

Hélicoptère

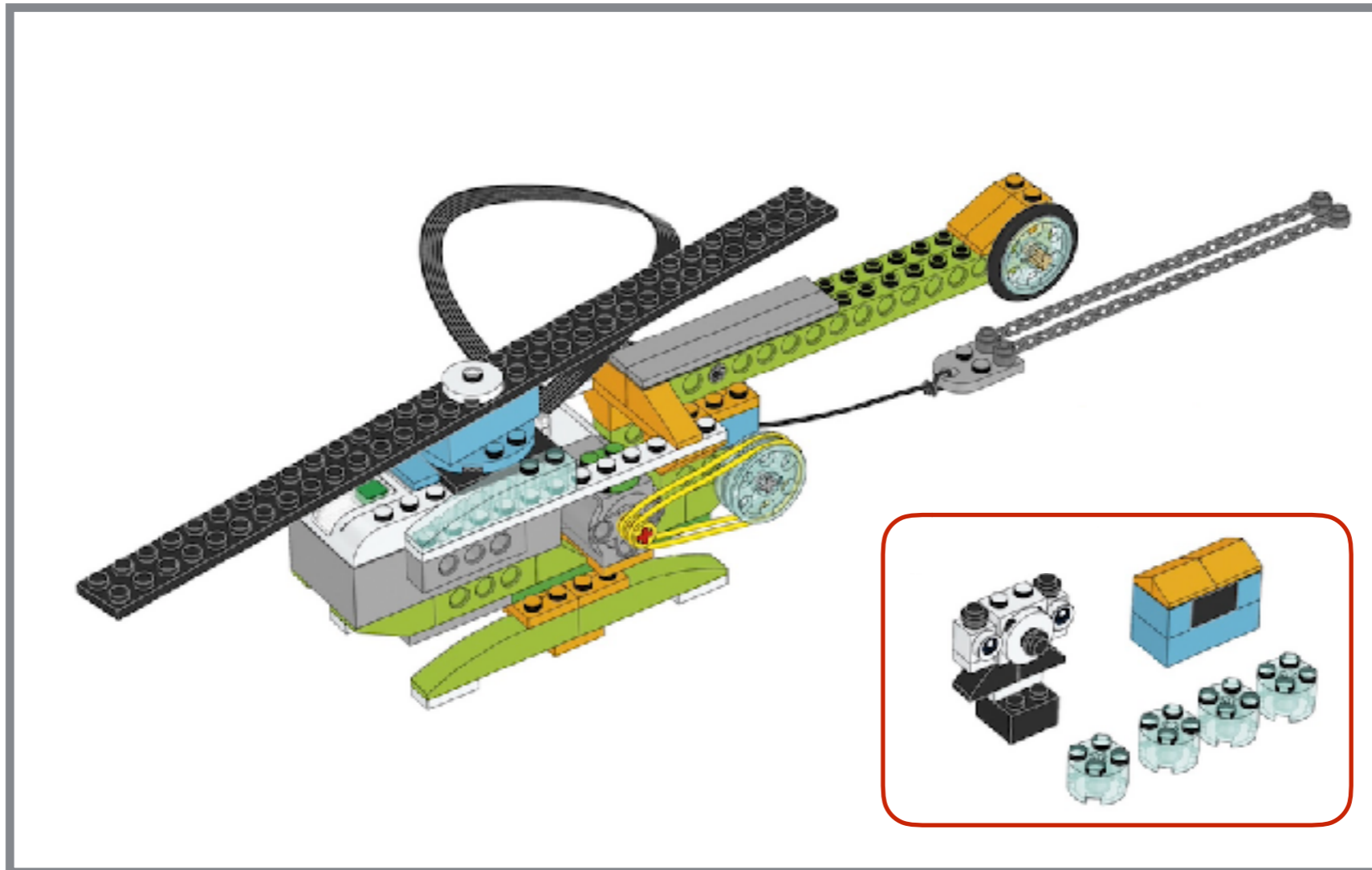

WeDo 2.0 de LEGO Education

Modification et bonification des plans par le Service national du RÉCIT à l'éducation préscolaire

Lynda O'Connell, conseillère pédagogique en TIC et Isabelle Therrien, enseignante à l'éducation préscolaire



Nombre d'étapes : 55

Nom original du modèle : Helicopter

Genre de déplacement : Enrouleur

Complément : Petits objets à soulever (étapes 45 à 55)

Remarques : Aucun capteur dans ce modèle

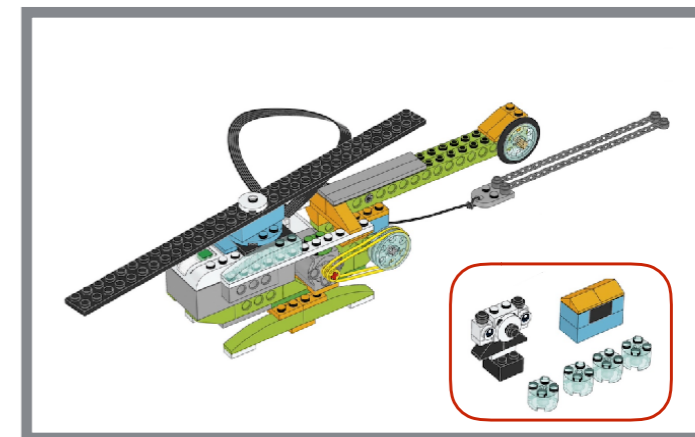

◆ 1 plaque de cadre, 4x4 (gris)

◆ 2 briques inclinées inversées 1x3/25° (vert citron)

1

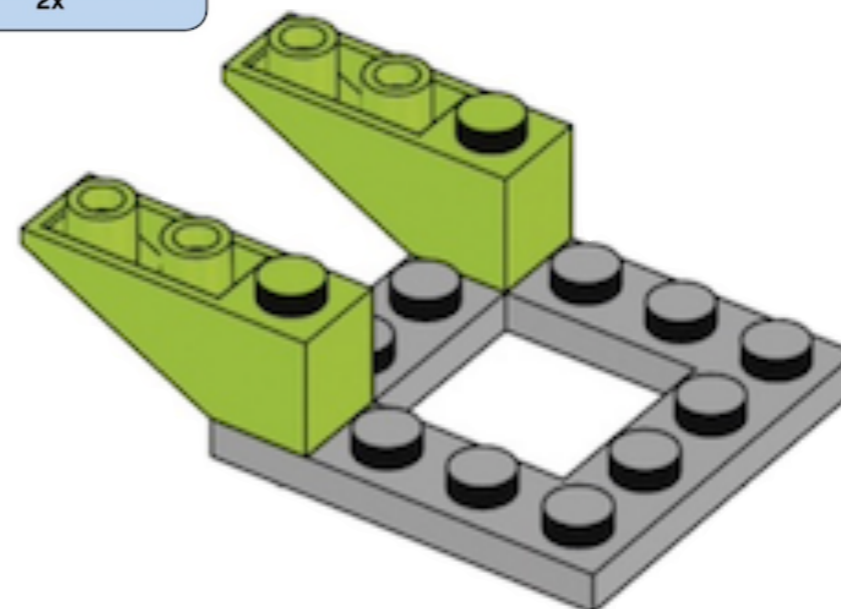
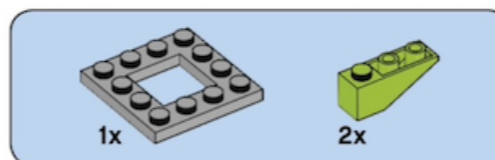

◆ 2 poutres perforées, 1x4 (vert citron)

2

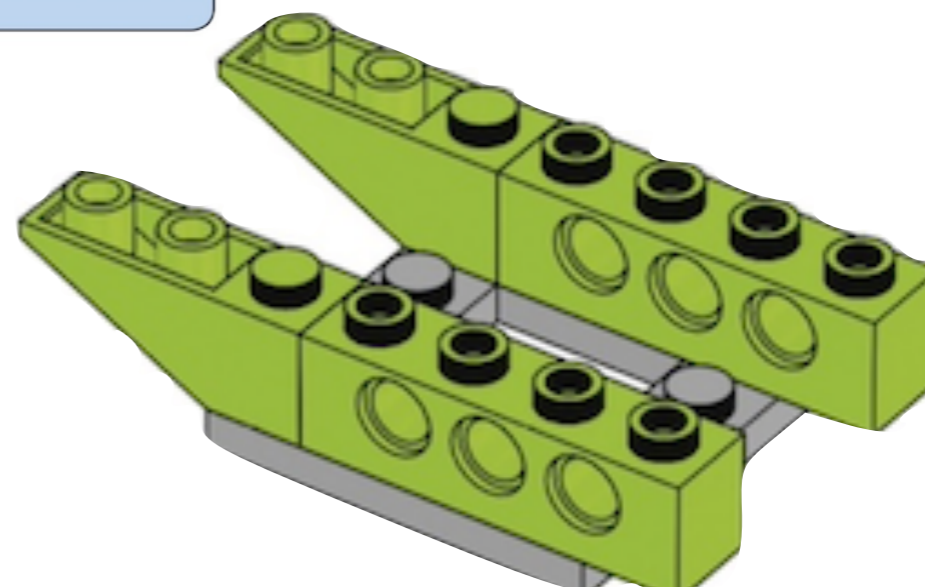
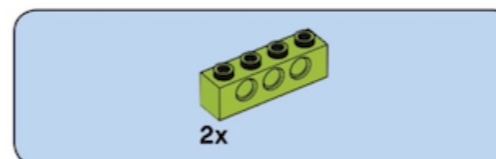

- ◆ 2 plaques percées, 2x8 (vert vif)

3

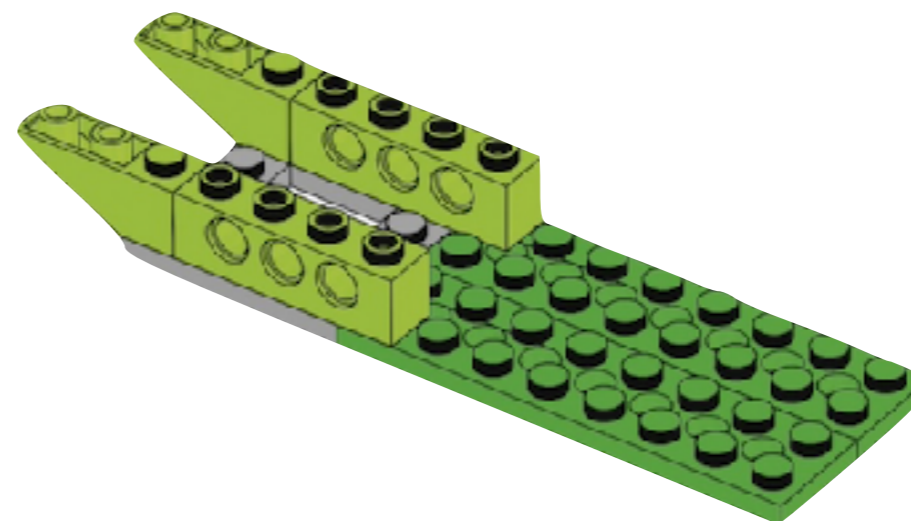
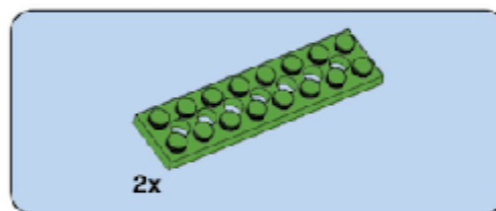

- ◆ 1 brique inclinée, 1x2/45° (vert citron)

- ◆ 1 plaque percée, 2x6 (orange vif)

4

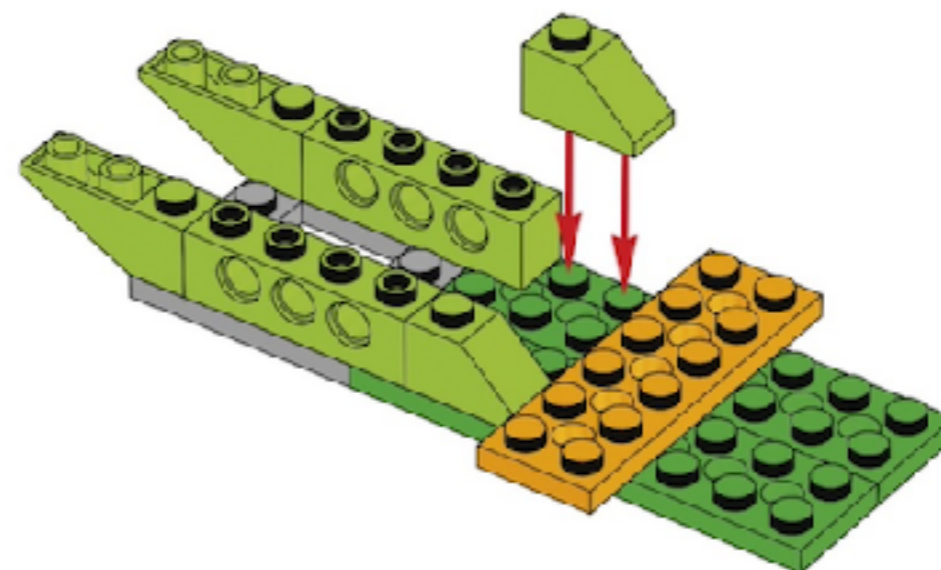
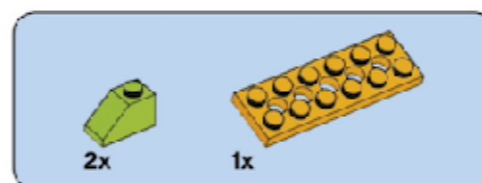

◆ 2 briques inclinées,
1x2/45° (vert citron)

◆ 2 briques inclinées
inversées, 1x3/25°
(vert citron)

5

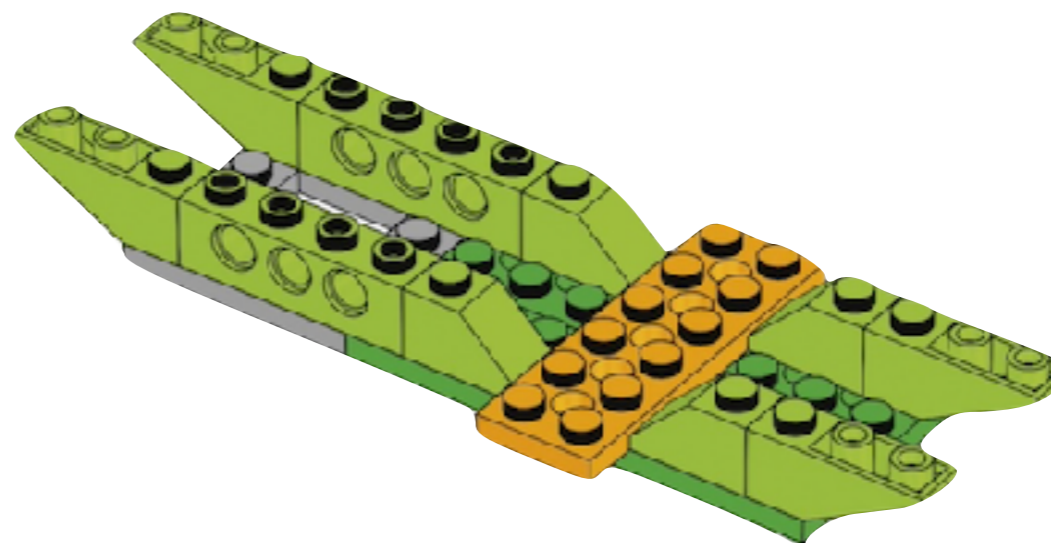
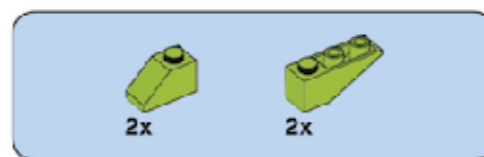

◆ 1 brique intelligente,
(blanc)

6

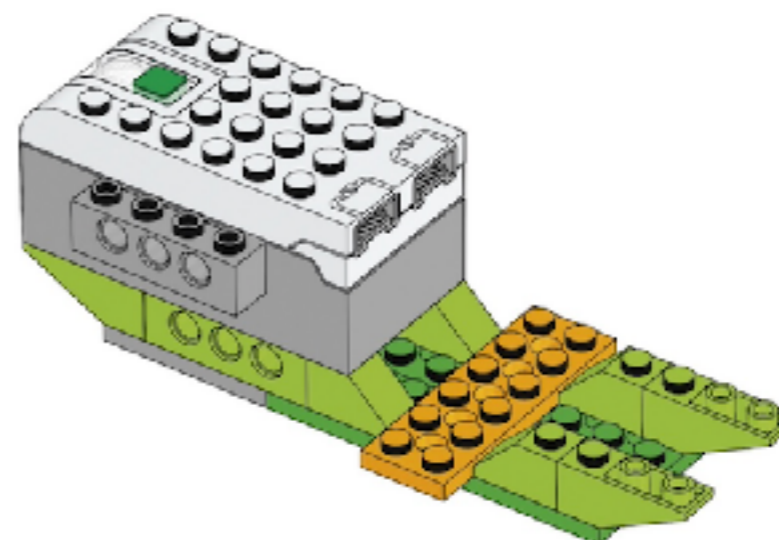
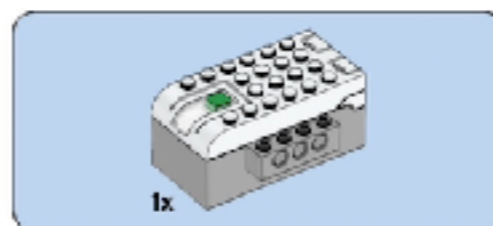

◆ 1 moteur moyen (blanc)

7

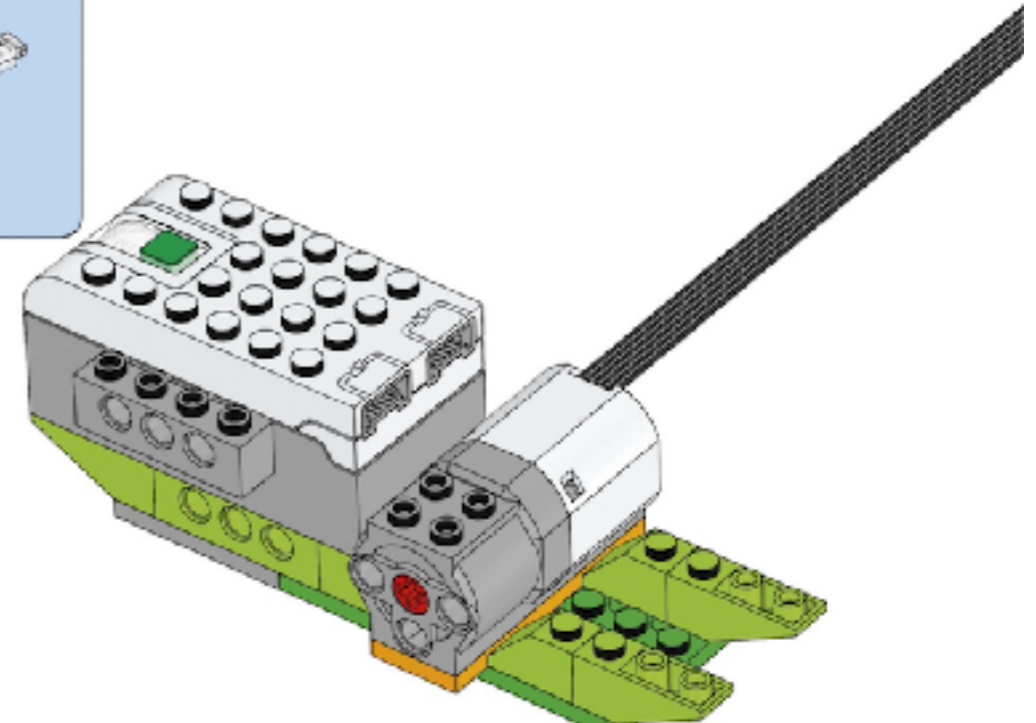
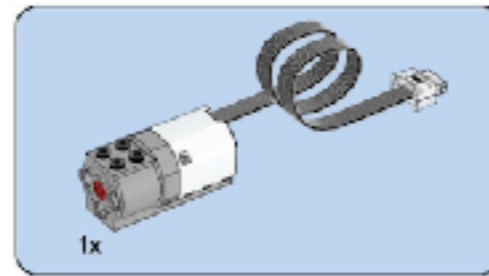

◆ 1 axe, 2 modules (rouge)

◆ 1 plaque ronde, 2x2 (vert vif)

8

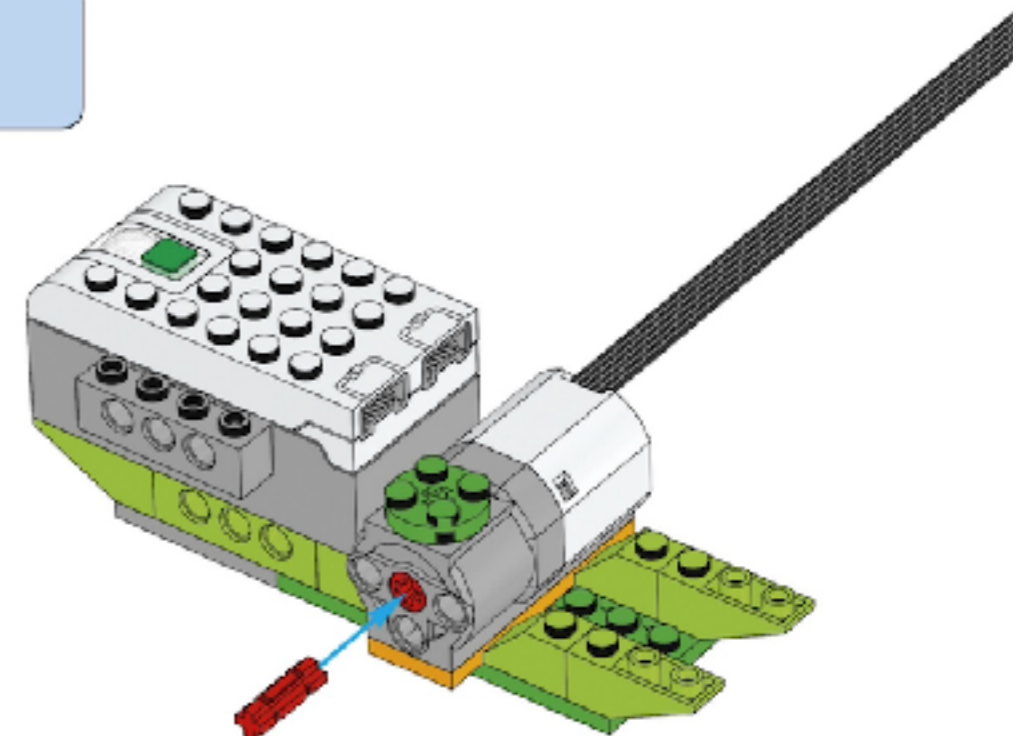

◆ 2 bagues/poulies, 1/2 module (jaune)

9

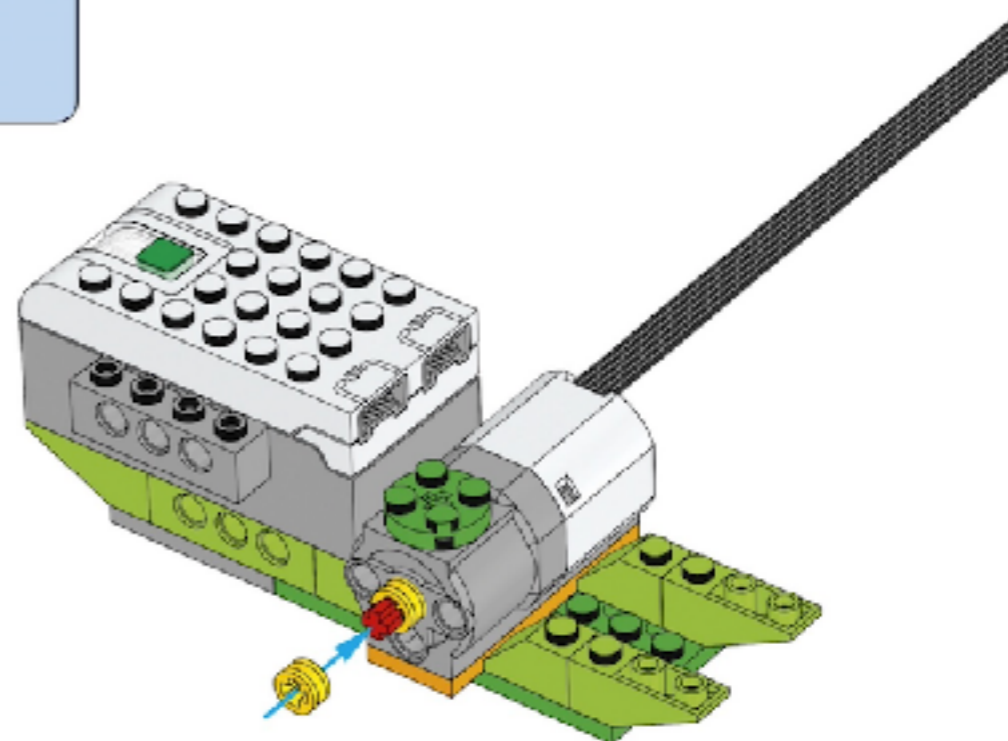

◆ 1 poutre perforée, 1x4 (vert citron)

10

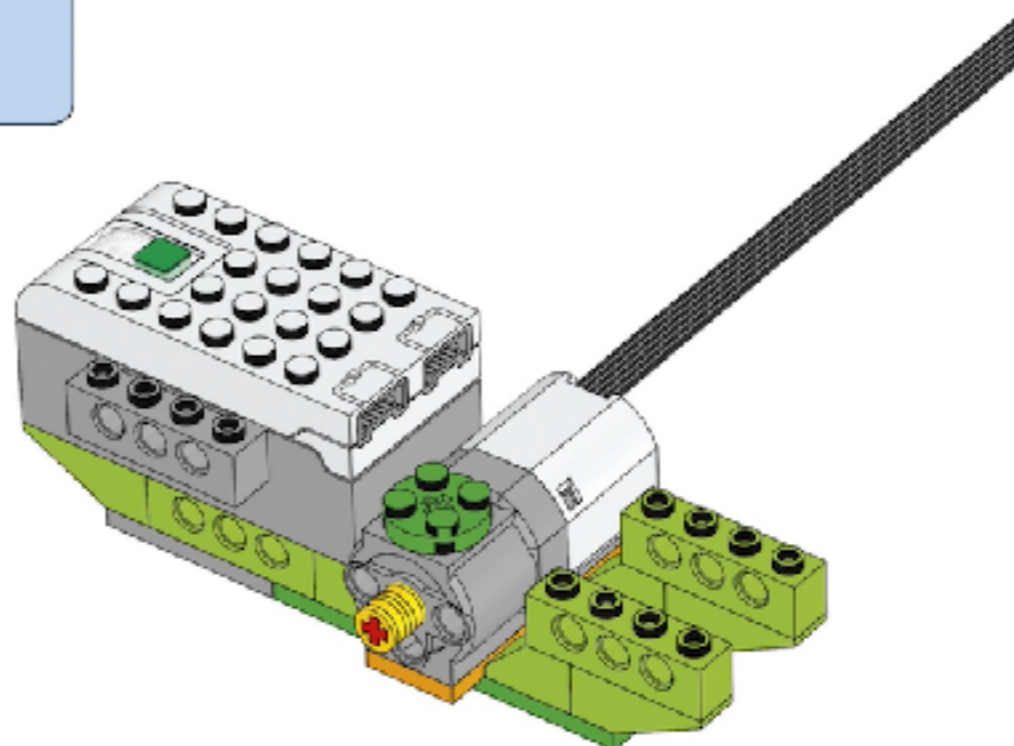
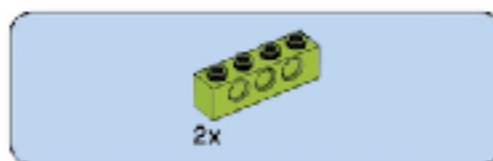

- ◆ 1 axe, 7 modules (gris)
- ◆ 1 bague/allonge d'axe, 2 modules (gris)

11

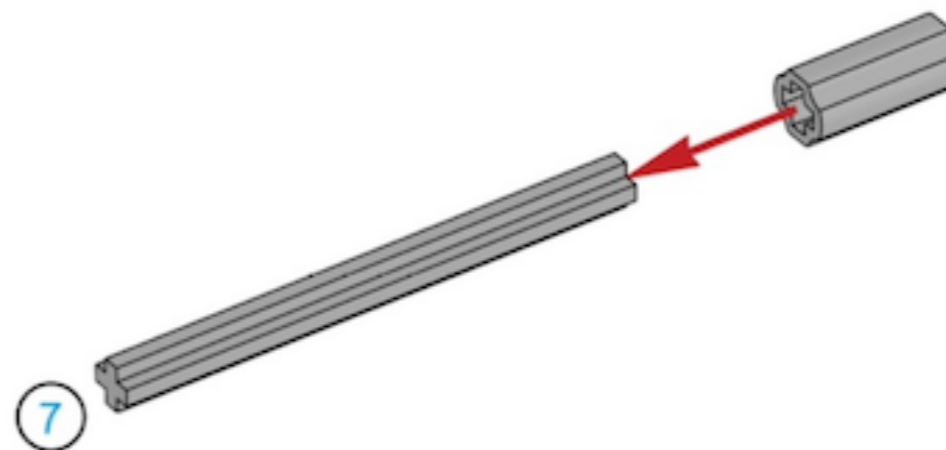
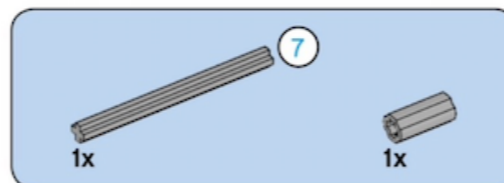

- ◆ 1 axe, 2 modules (rouge)

12

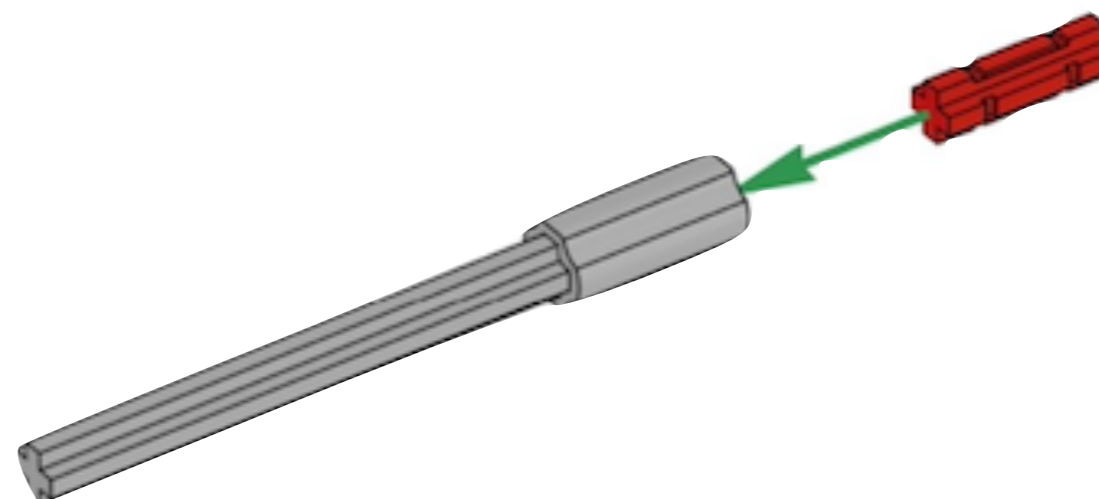
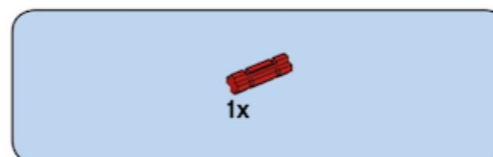

◆ 1 double engrenage conique, 12 dents (noir)

13

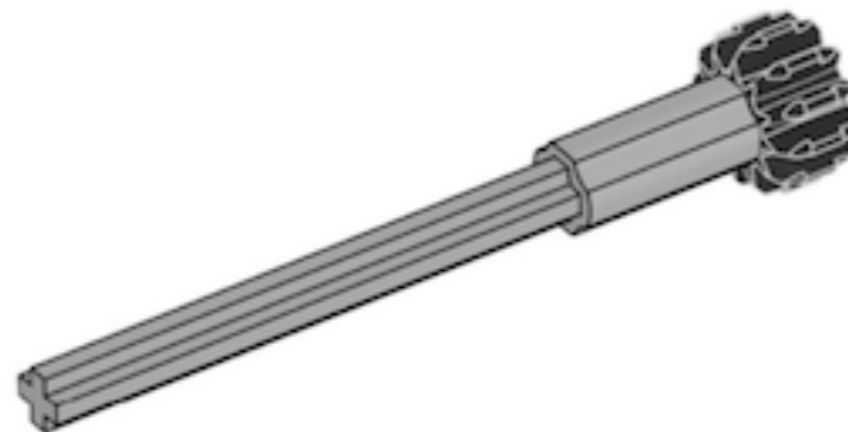

14

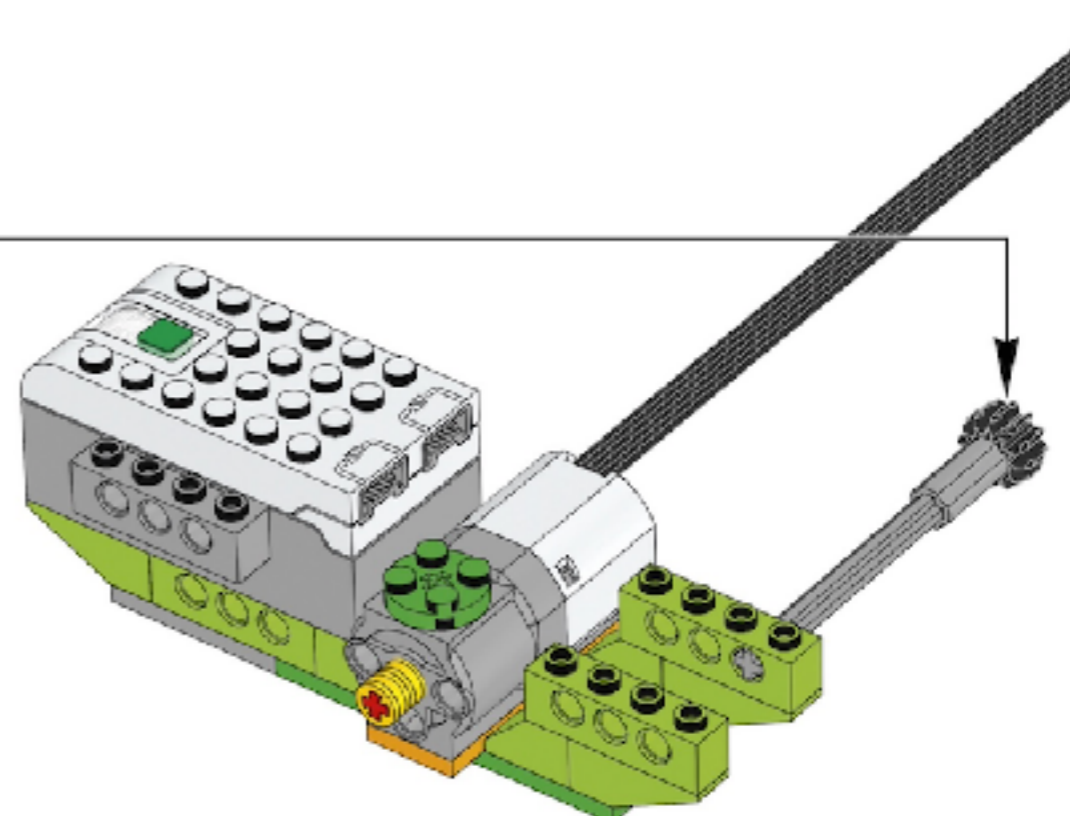

◆ 1 bobine (gris foncé)

◆ 1 ficelle, 50 cm (noir)

15

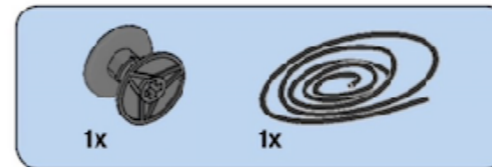

◆ 1 plaque percée, 2x3 (gris)

16



17

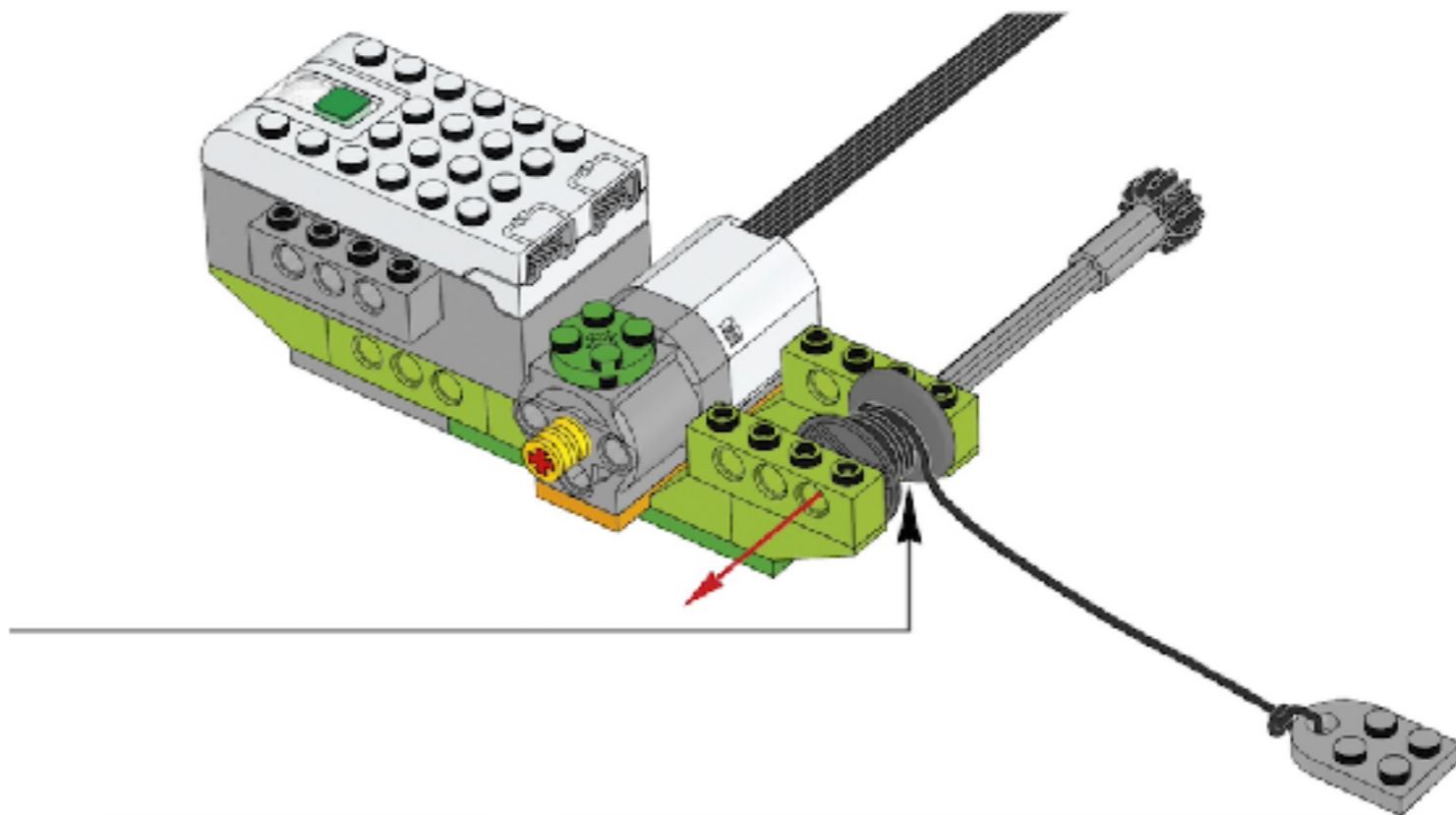

◆ 1 bague, 1 module (gris)

18

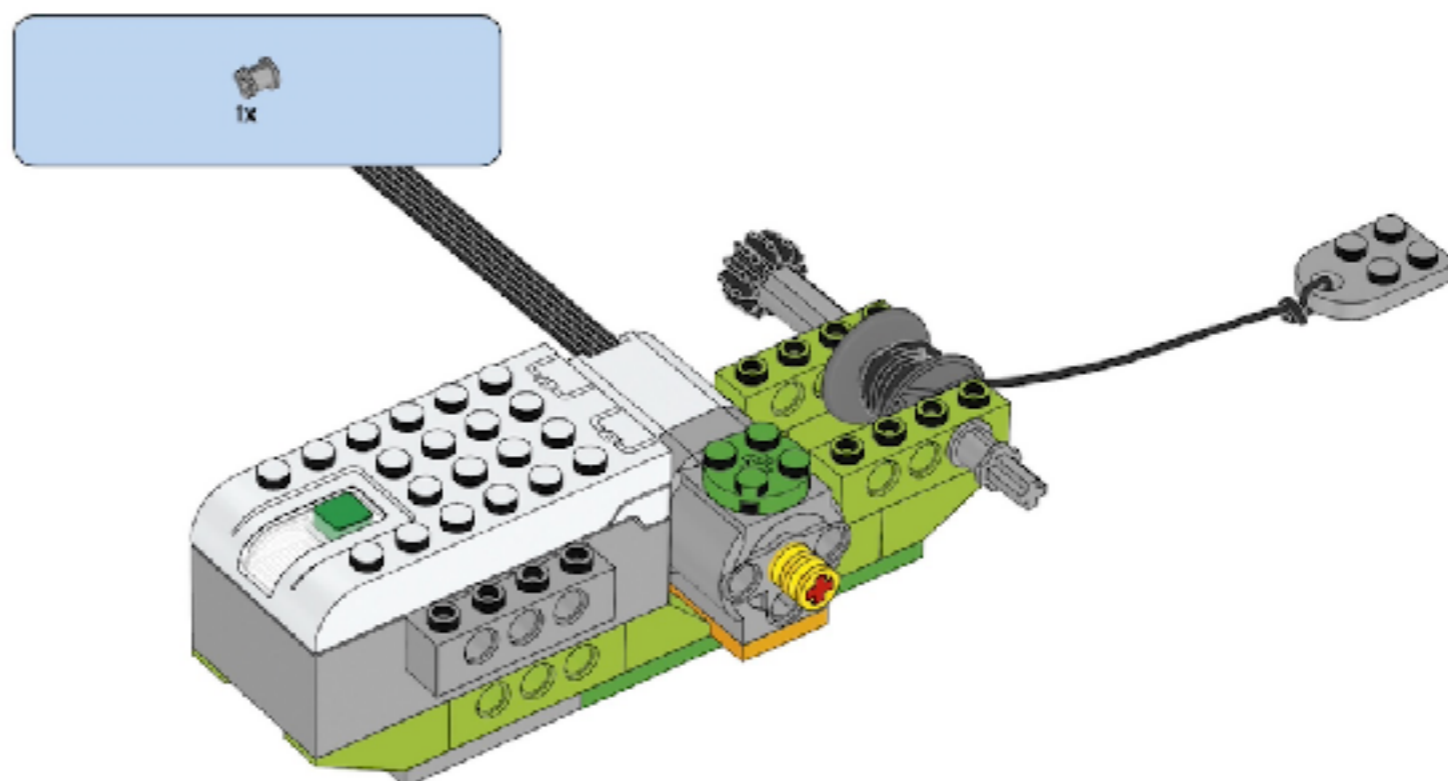

- ◆ 2 moyeux/poulies, 24x4 mm (bleu clair transparent)

19

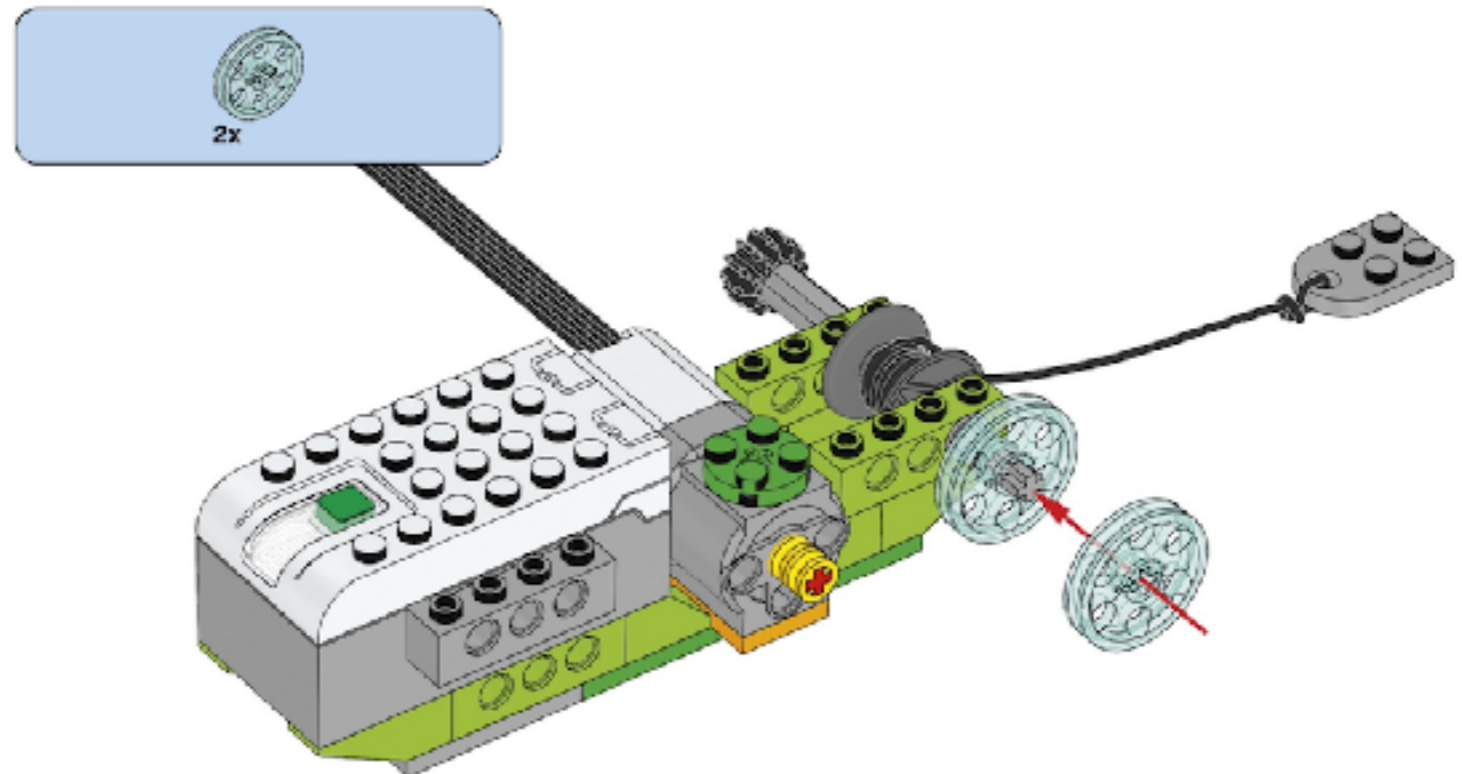

- ◆ 4 briques inclinées inversées, 1x2/45° (orange vif)

20

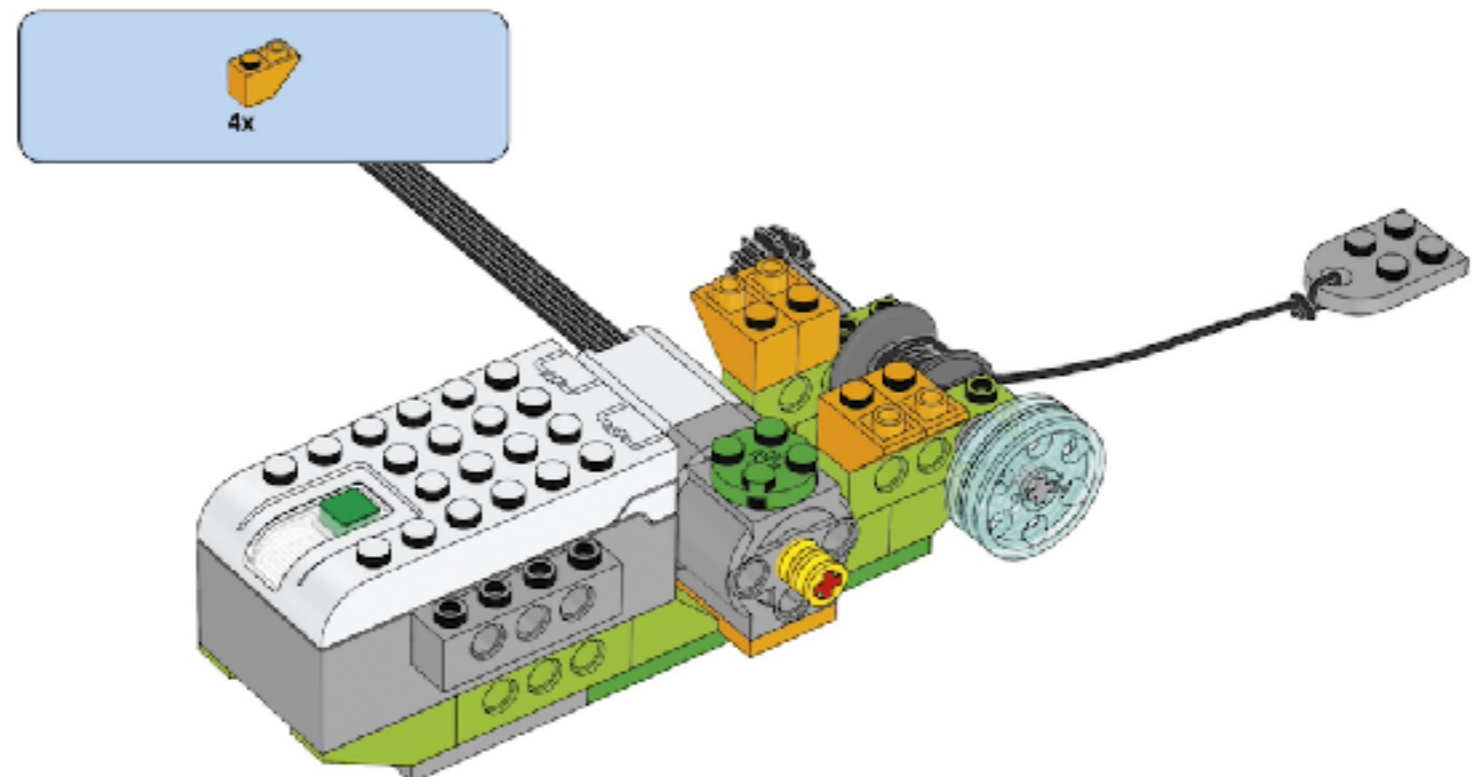

- ◆ 1 plaque percée, 2x4 (orange vif)

21

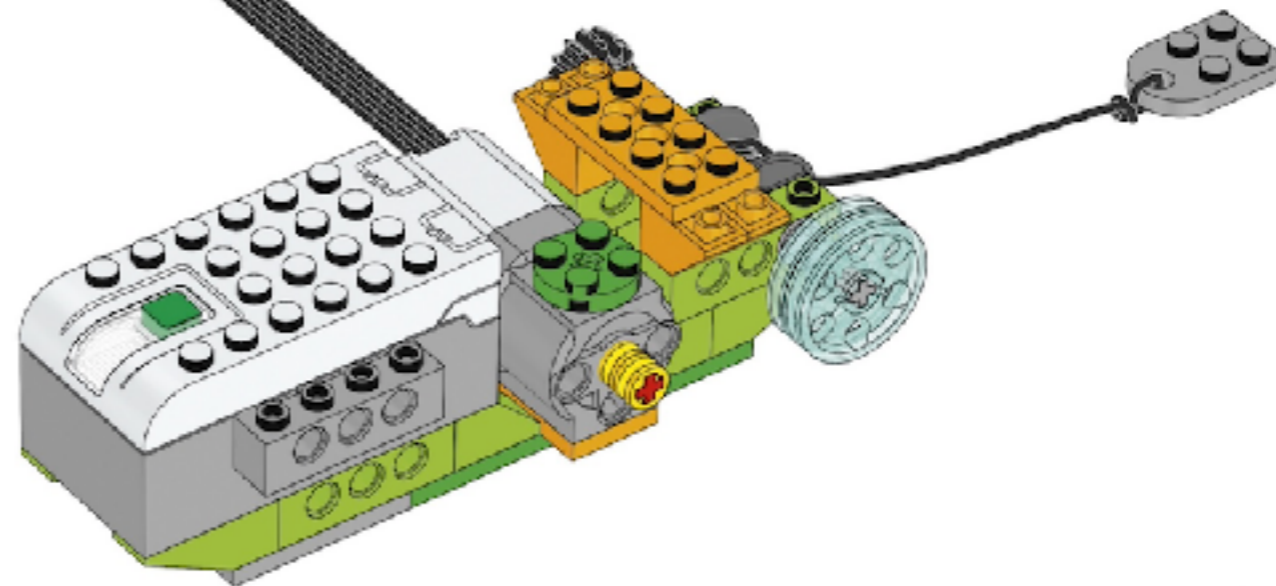
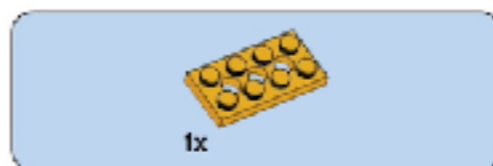

- ◆ 2 plaques, 1x12 (blanc)

22

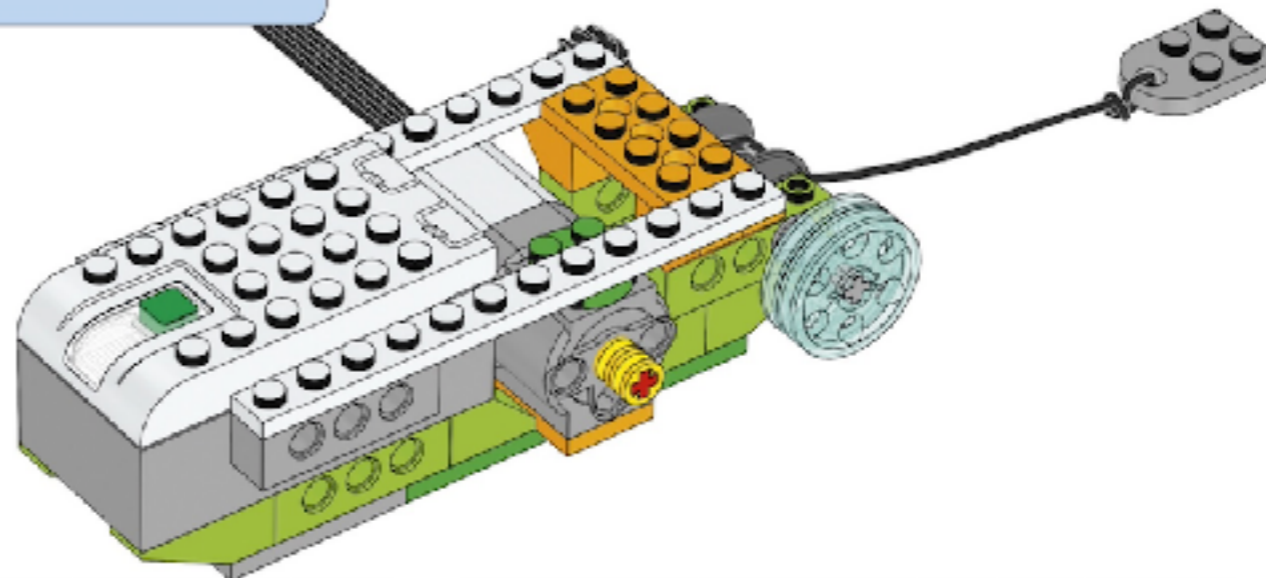
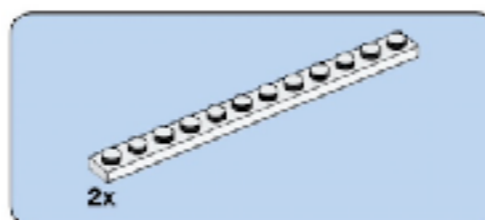

◆ 1 brique, 1x2 (bleu azur)

23

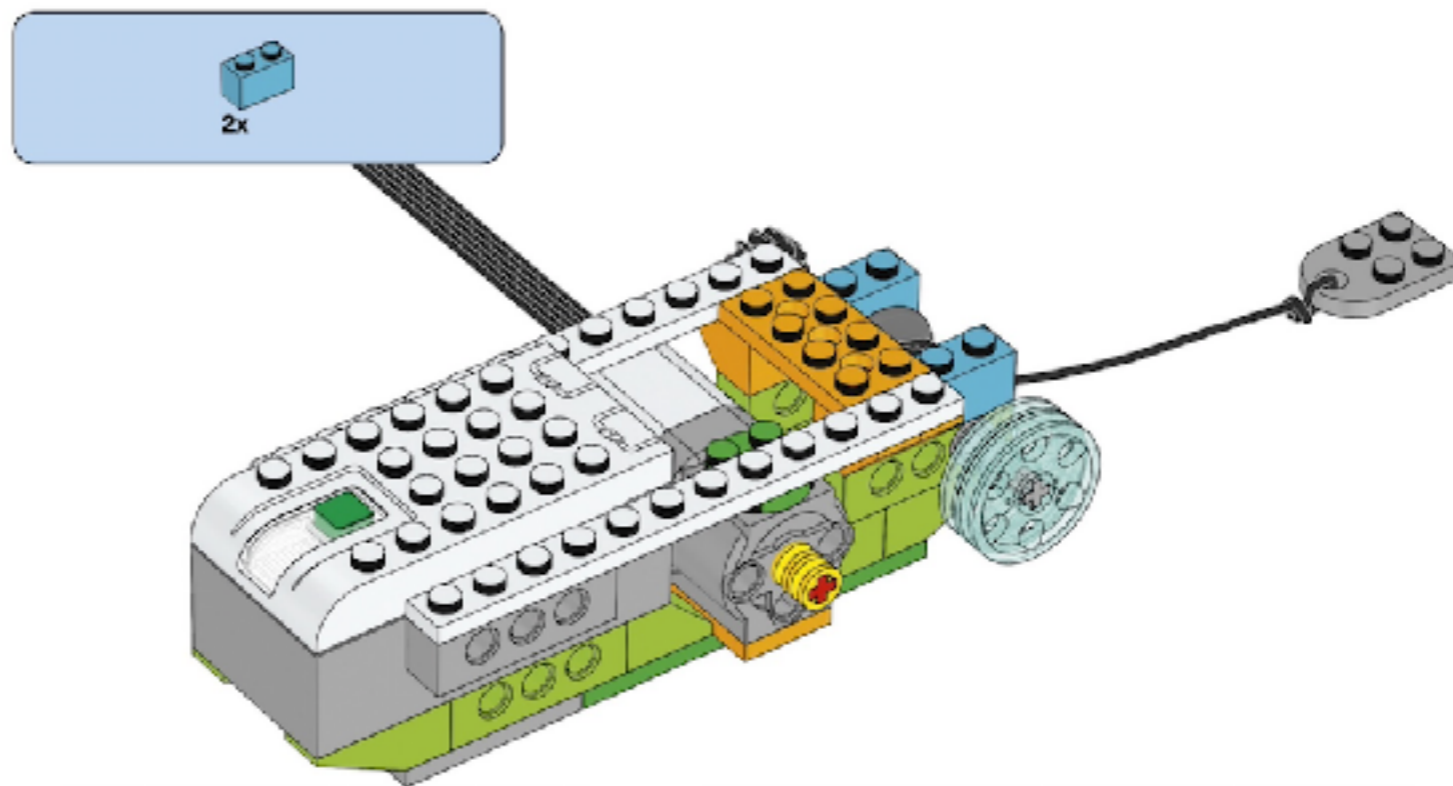

◆ 1 plaque percée, 2x4 (orange vif)

24

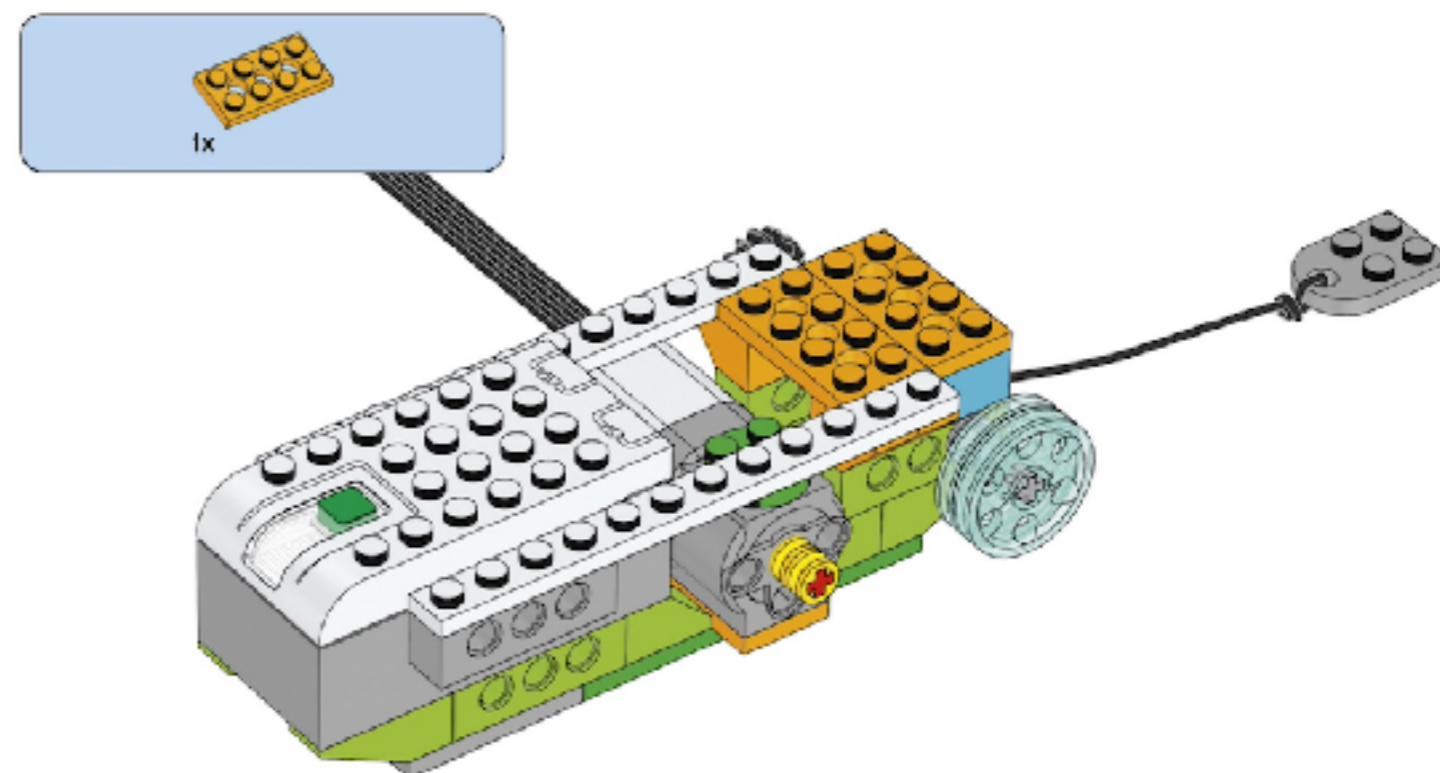

- ◆ 2 courroies, 33 mm (jaunes)

25

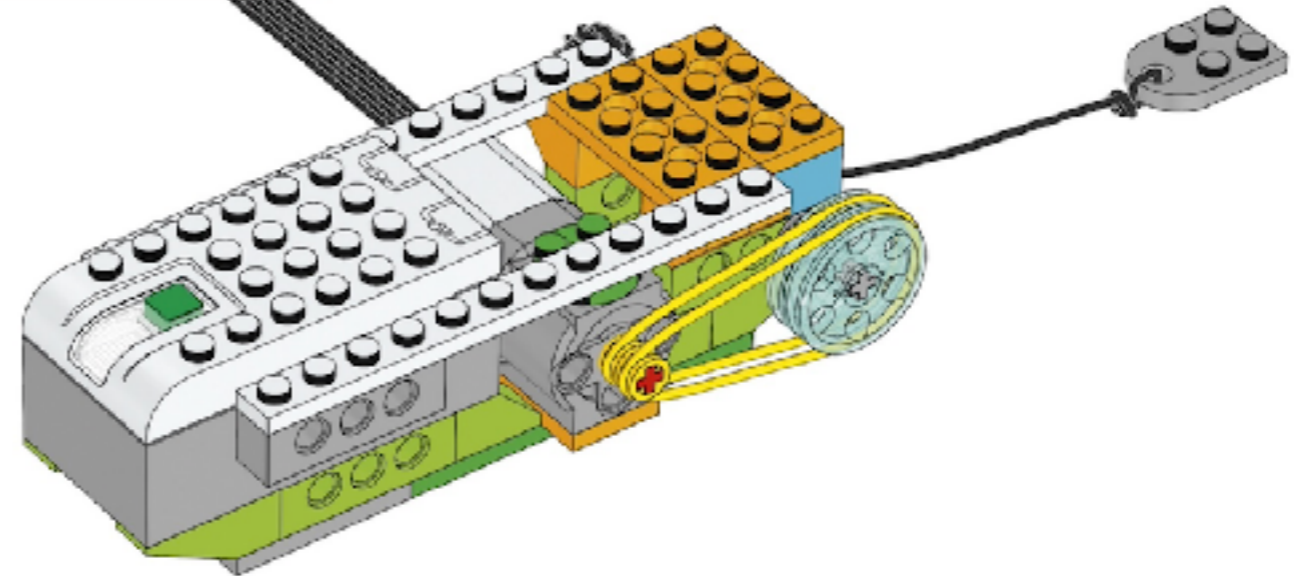
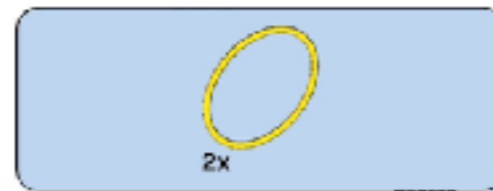

- ◆ 2 briques incurvées, 1x6 (bleu clair transparent)
- ◆ 2 briques inclinées, 1x3/25° (orange vif)

26

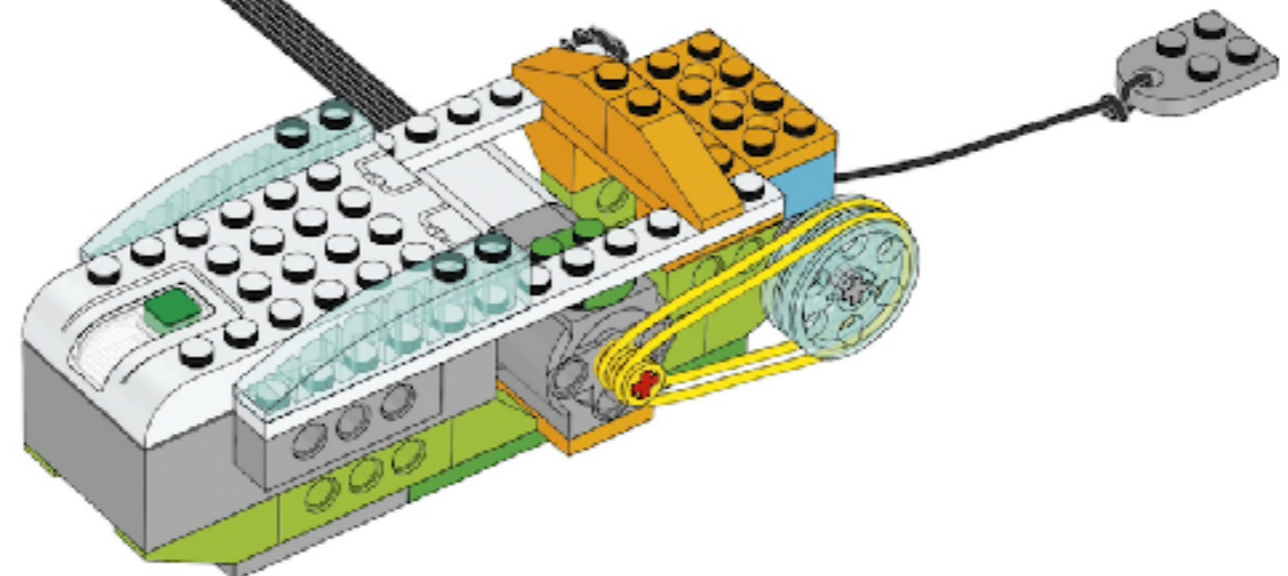
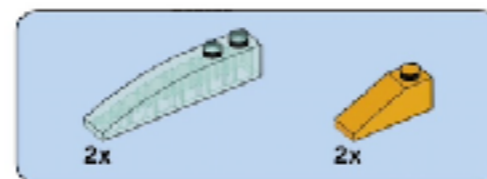

- ◆ 1 fond de plaque tournante, 4x4 (noir)
- ◆ 1 tuile, 1x2 (bleu azur)

27

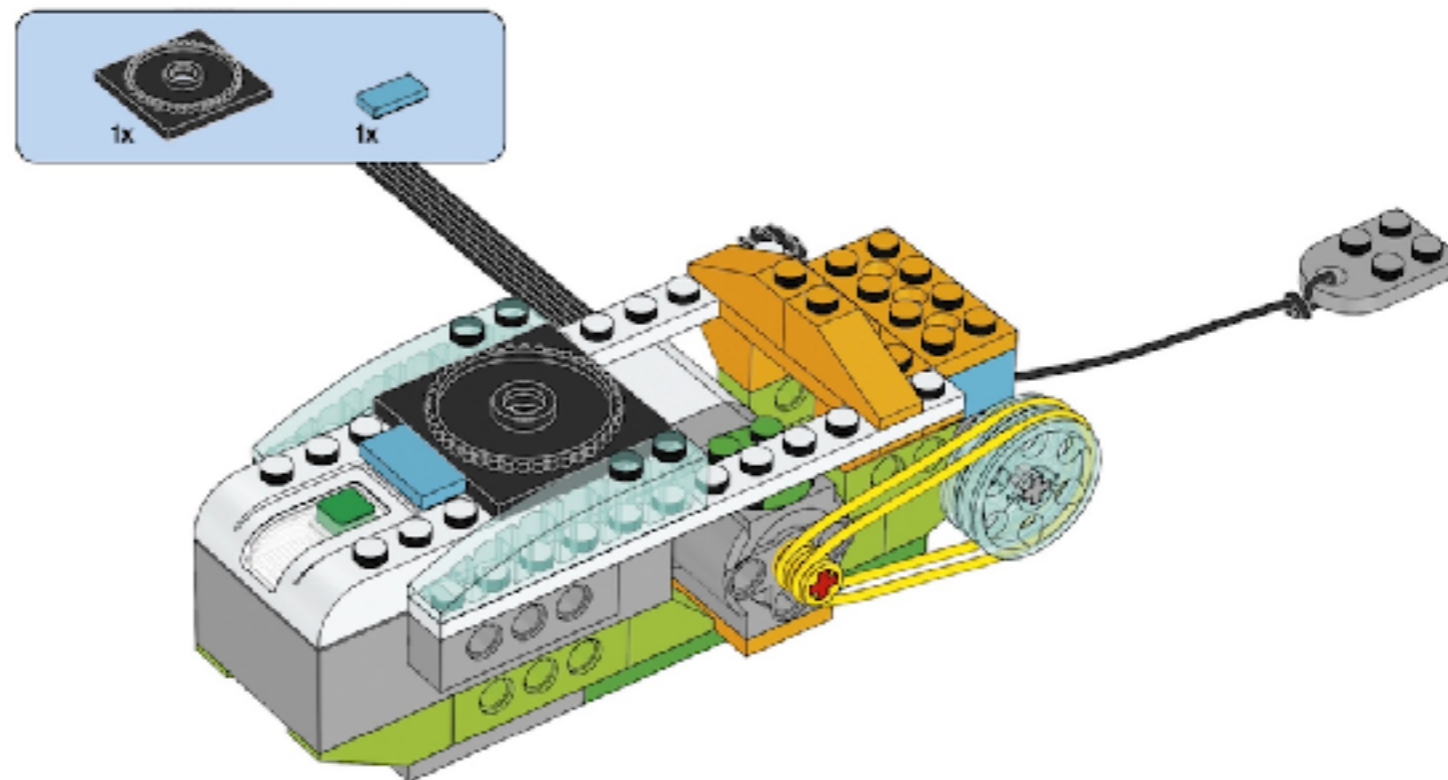

- ◆ 1 poutre perforée, 1x12 (vert citron)
- ◆ 2 chevilles à friction, 2 modules (noir)

28

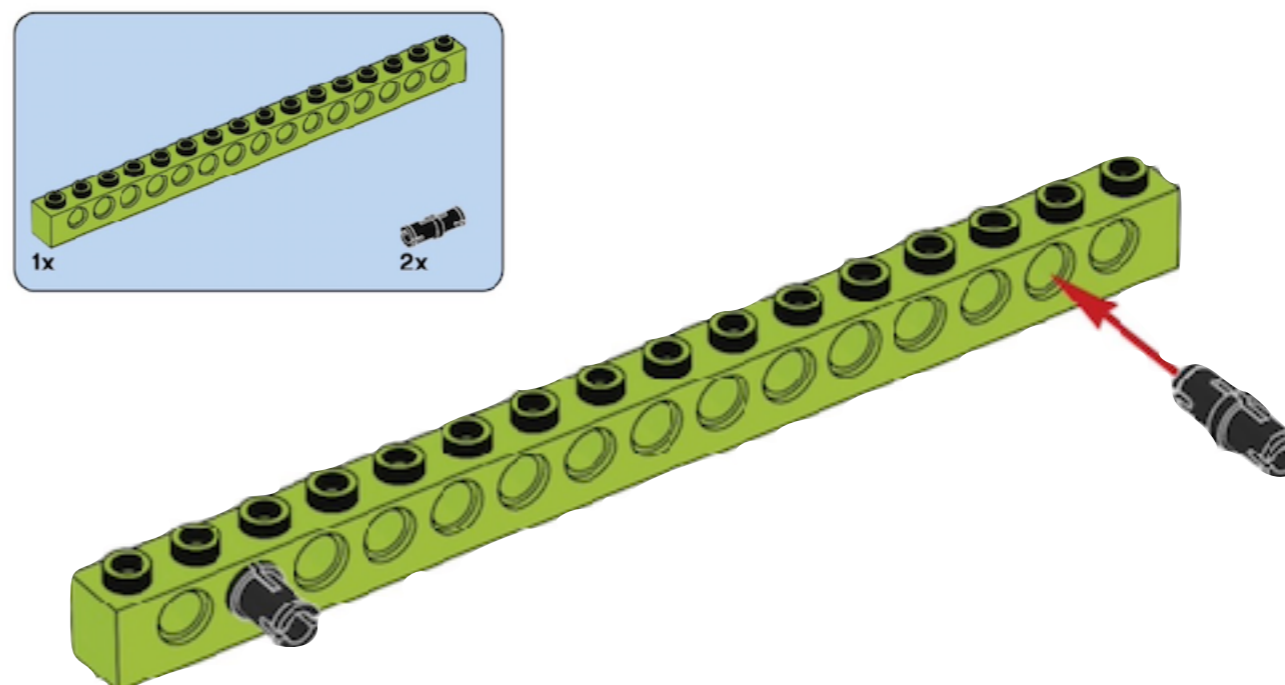

- ◆ 1 poutre perforée, 1x12 (vert citron)

29

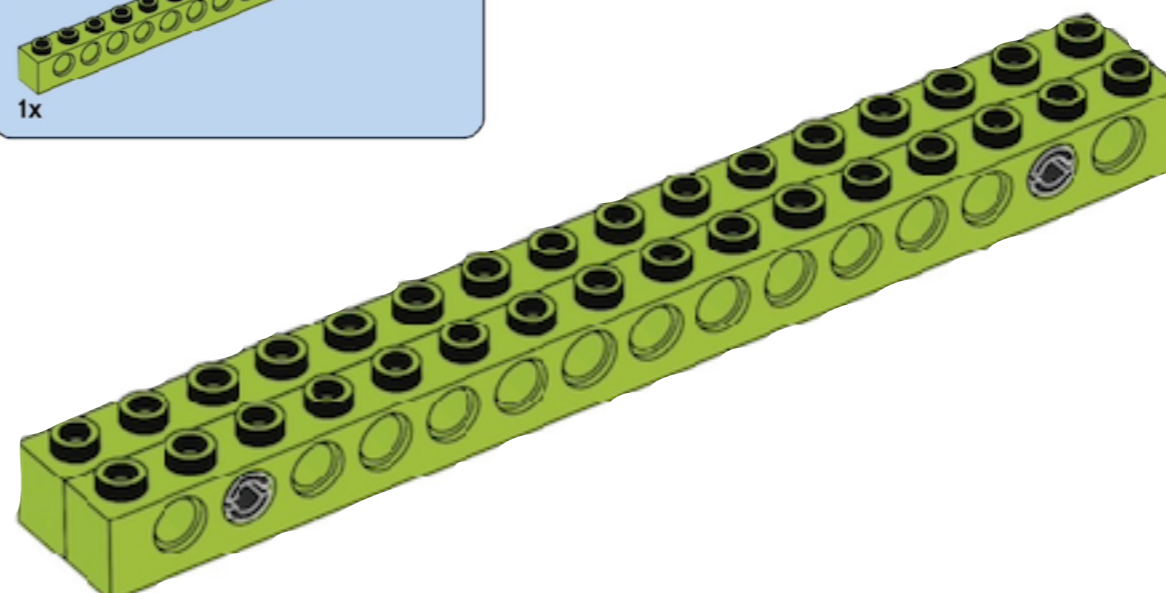
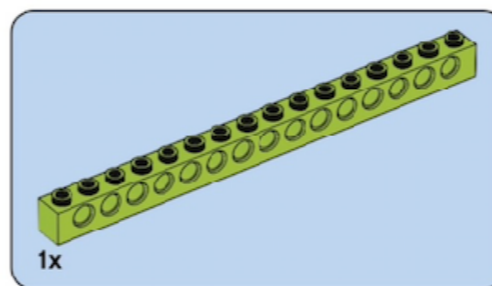

- ◆ 1 cheville sans friction/axe, 1 module/1 module (beige)
- ◆ 2 briques inclinées, 1x3/25° (orange vif)

30

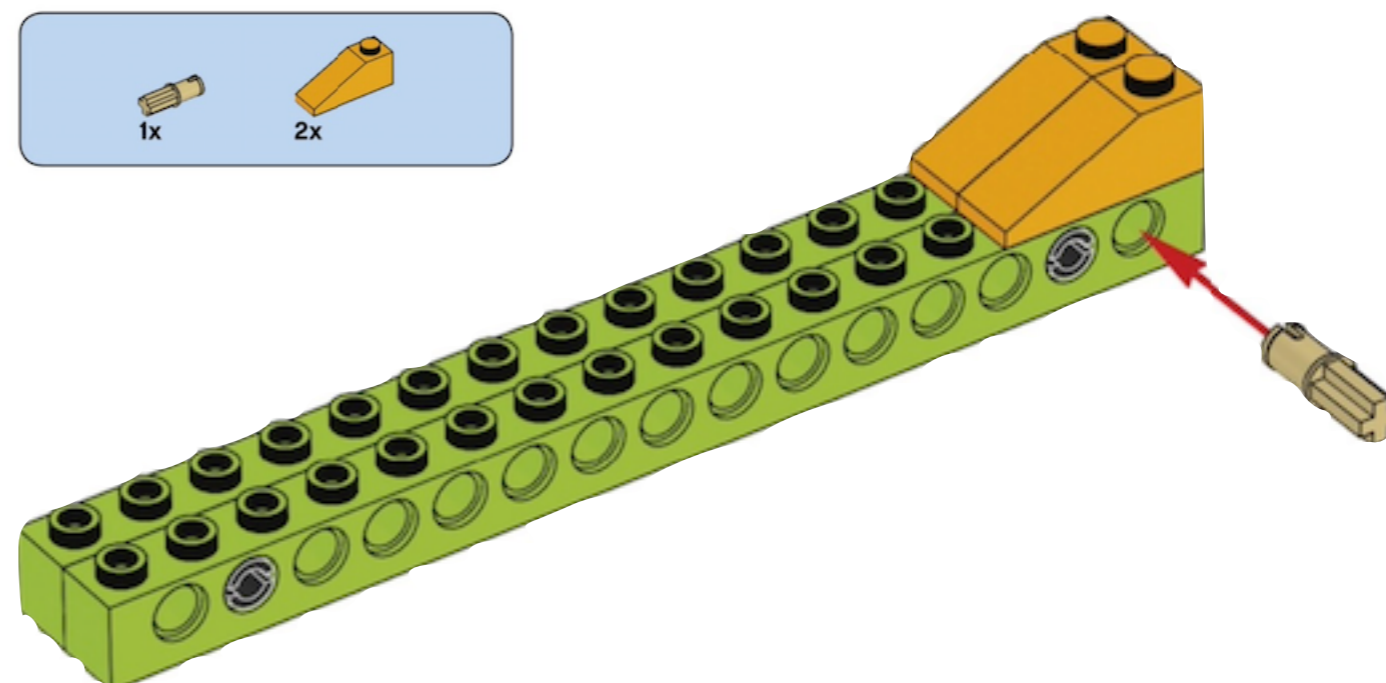
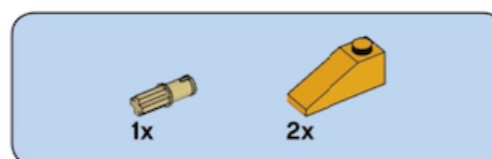

- ◆ 1 pneu, 30, 4x4 mm (noir)
- ◆ 1 moyeu/poulie, 24x4 mm (bleu clair transparent)

31

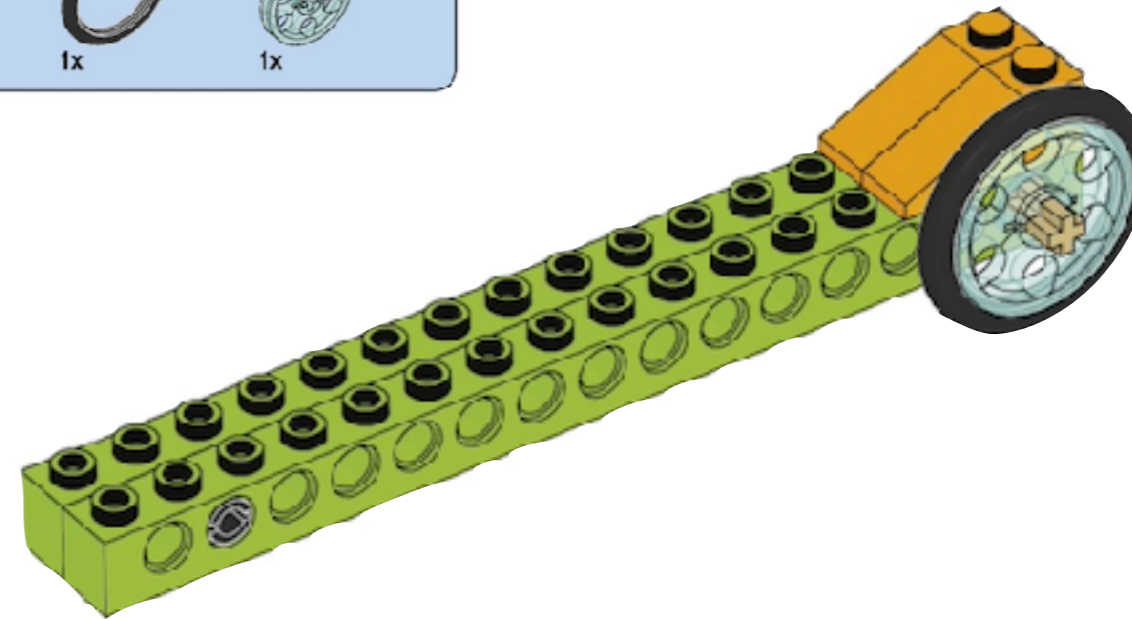

32

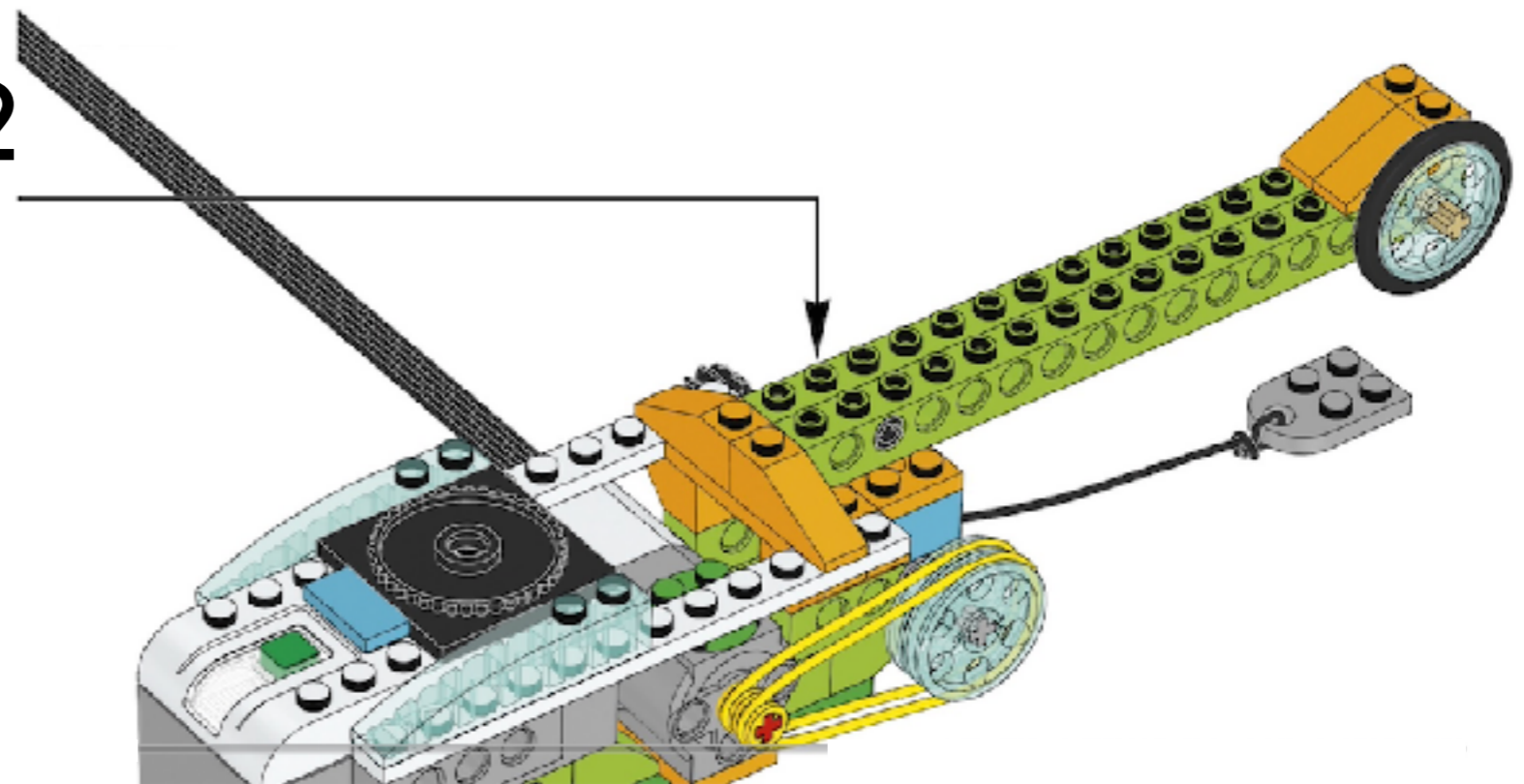

◆ 2 tuiles, 1x8 (gris)

33

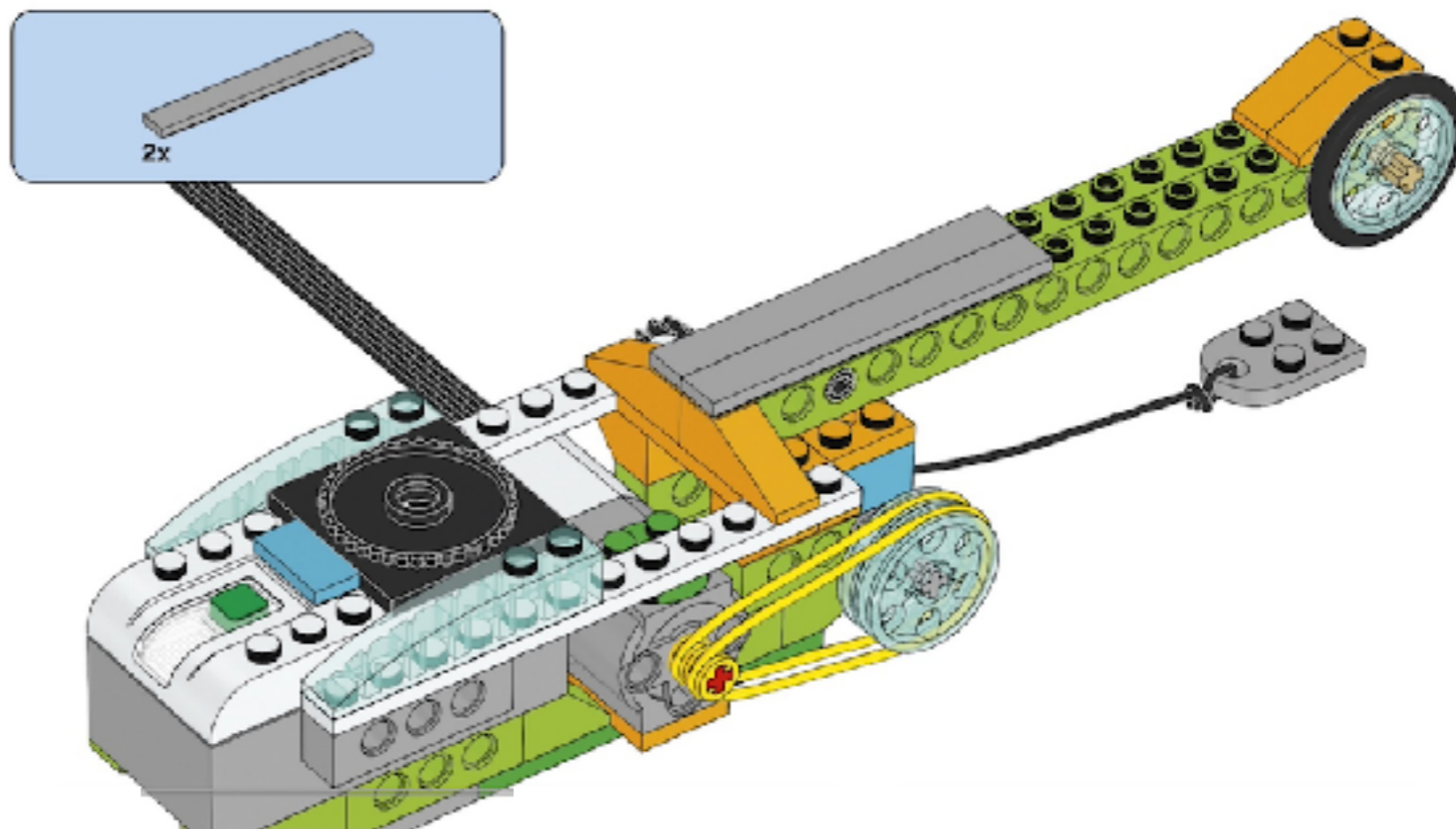

◆ 1 plaque perforée, 2x6 (orange vif)

34

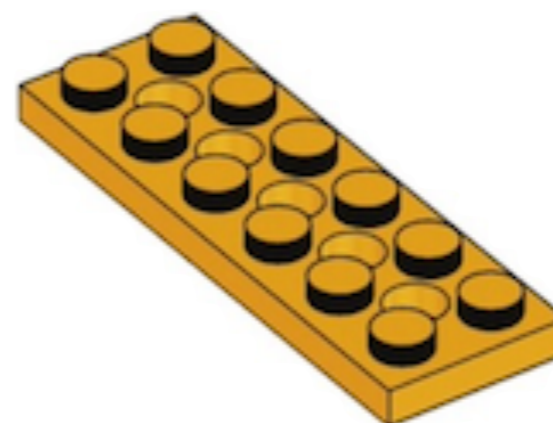
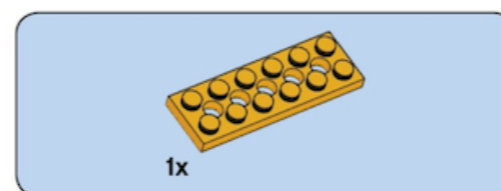

- ◆ 1 brique, 2x4 (orange vif)

35

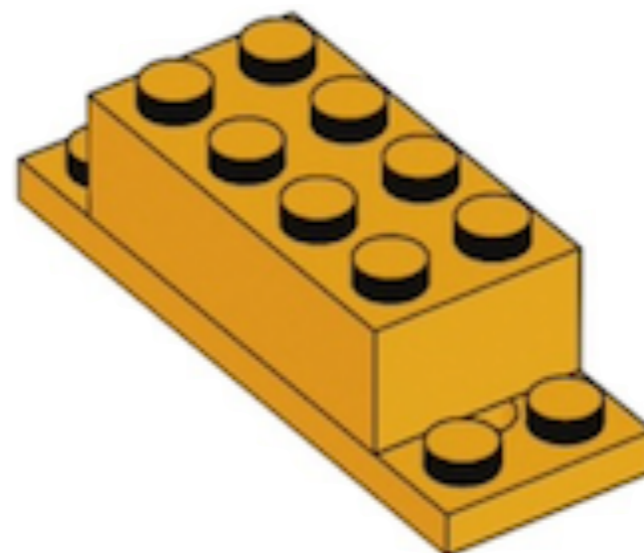
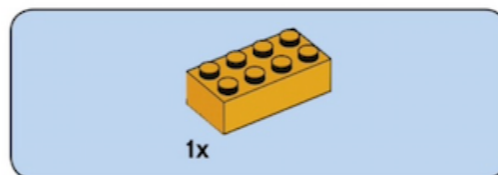

- ◆ 4 plaques, 1x2 (blanc)

- ◆ 4 briques incurvées, 1x6 (vert citron)

36

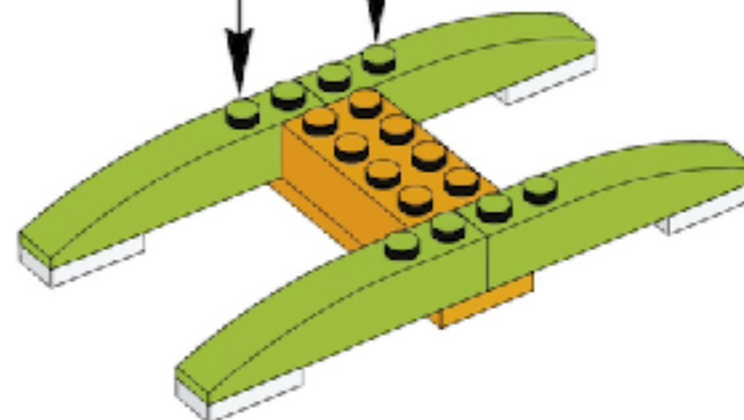
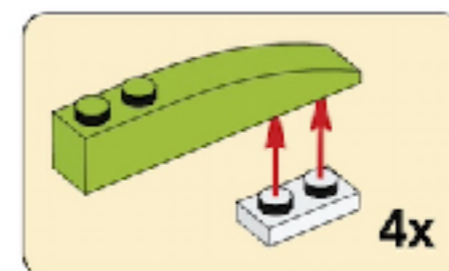
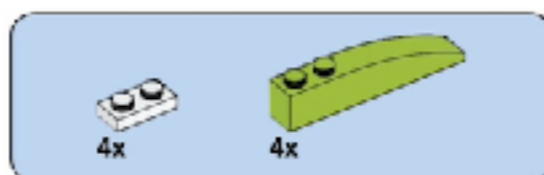

◆ 2 plaques percées, 2x6
(orange vif)

37

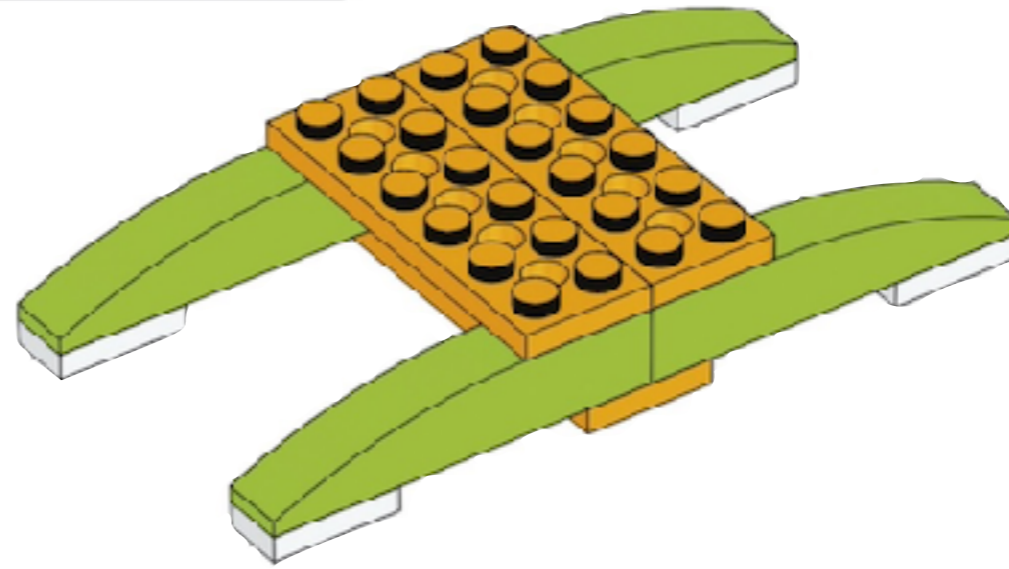
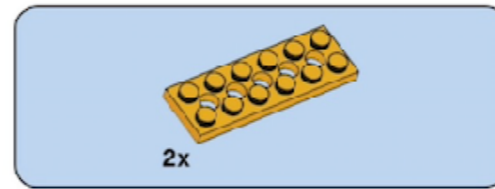

38

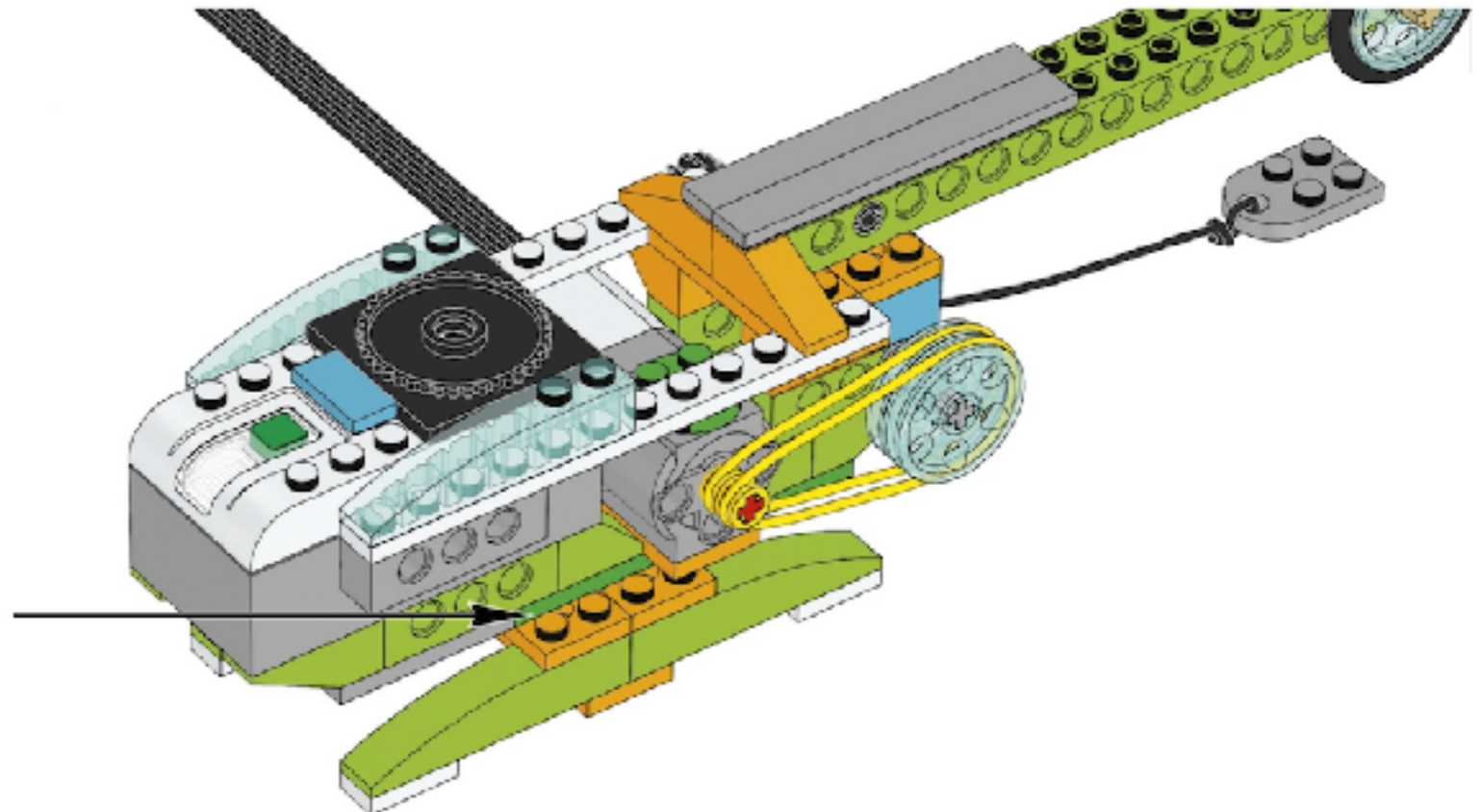

39

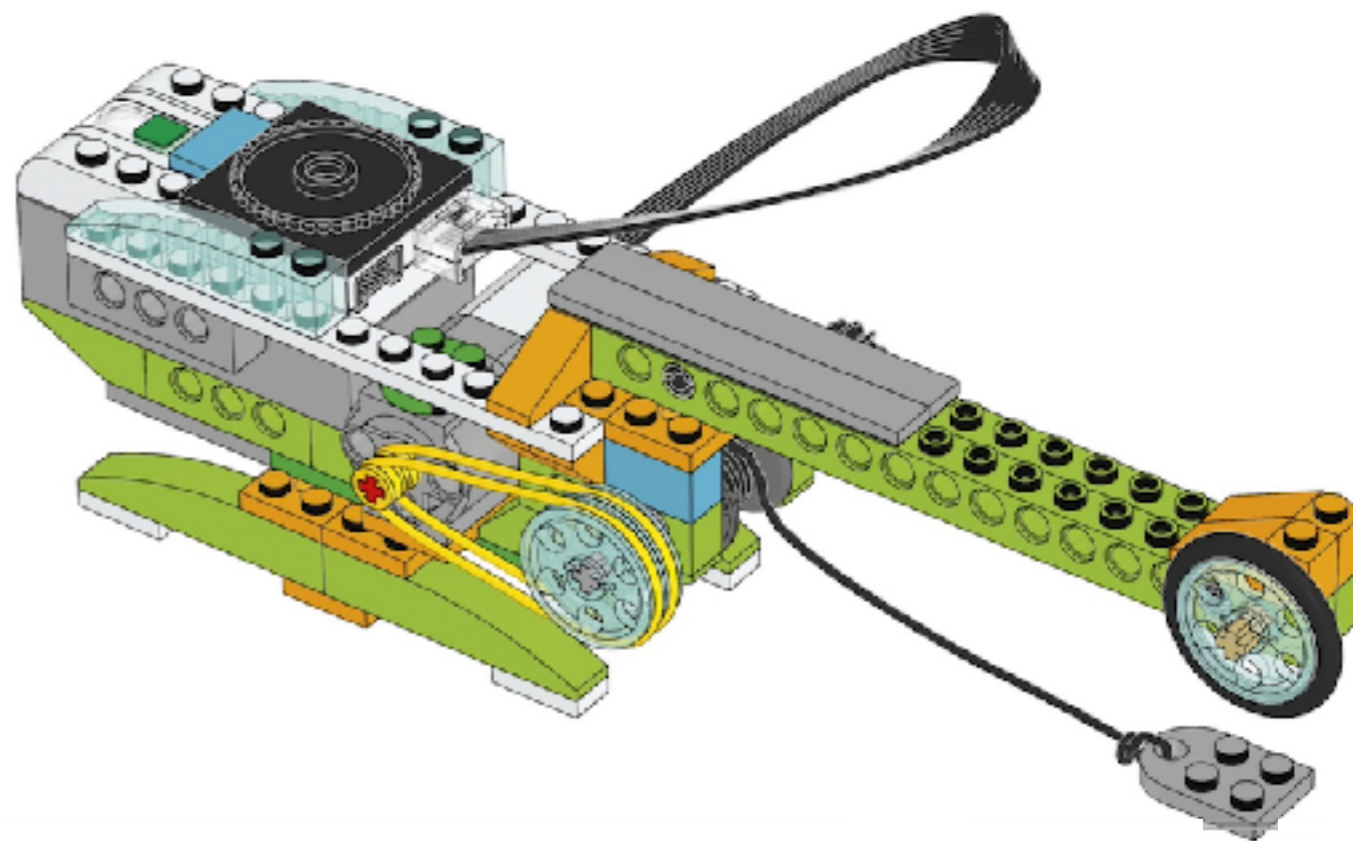

◆ 1 brique, 2x4 (bleu azur)

◆ 1 plaque ronde, 4x4 (bleu azur)

40

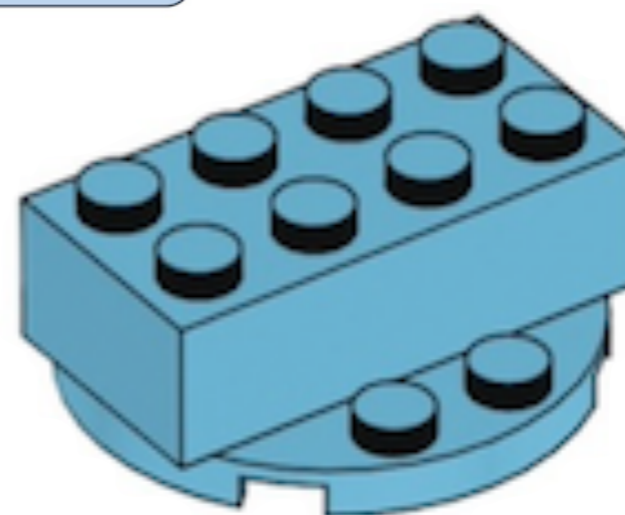
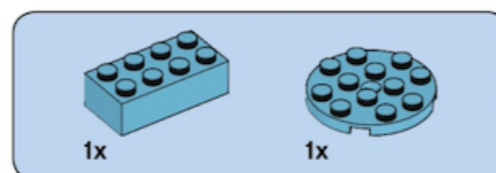

- ◆ 1 plaque, 2x16 (noir)

41

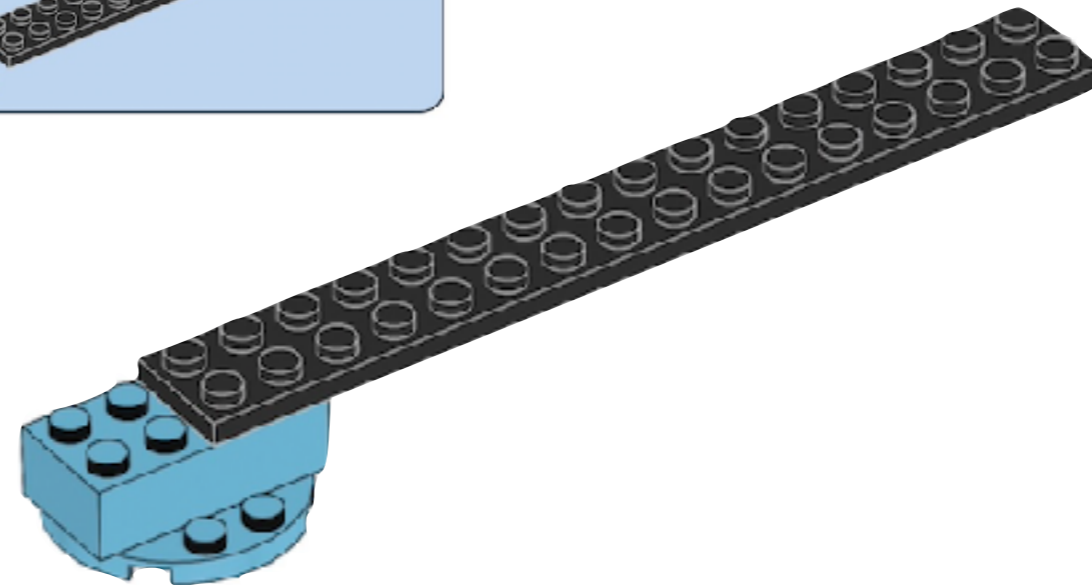
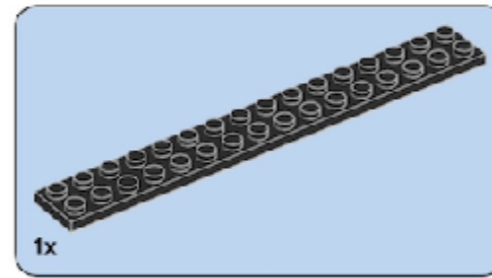

- ◆ 1 plaque, 2x16 (noir)
- ◆ 1 plaque ronde avec 1 picot, 2x2 (blanc)

42

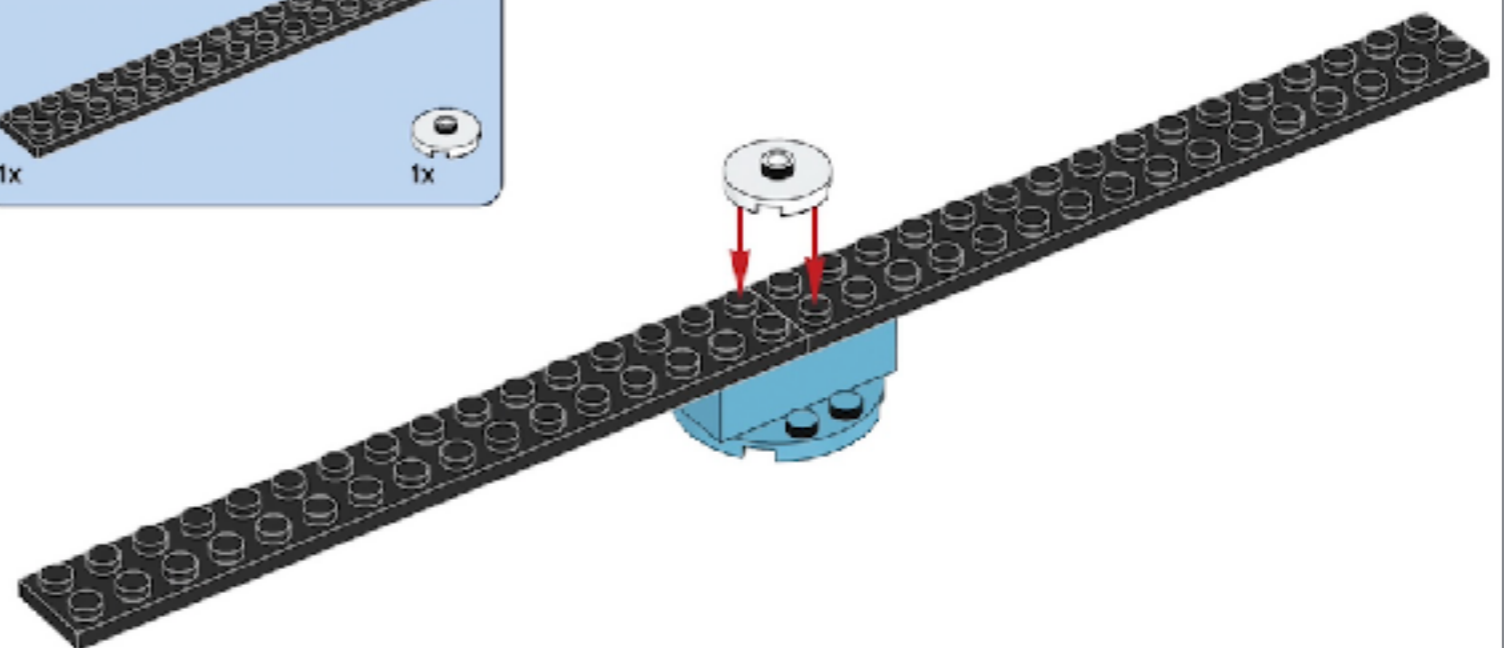
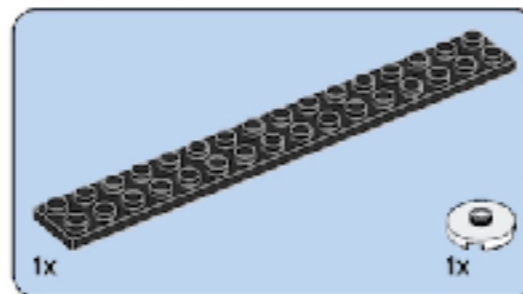

- ◆ 1 brique, 2x4 (bleu azur)

45

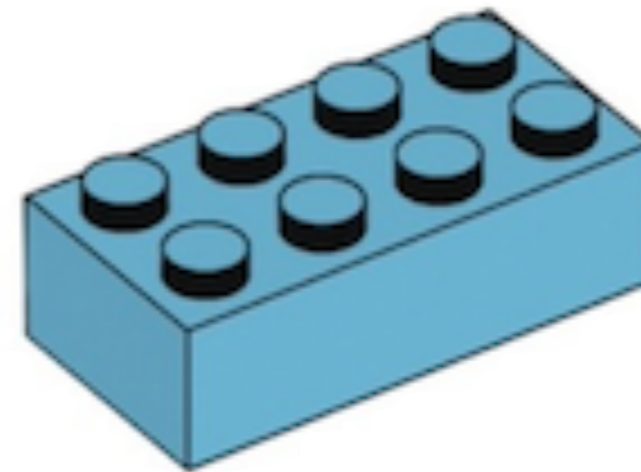
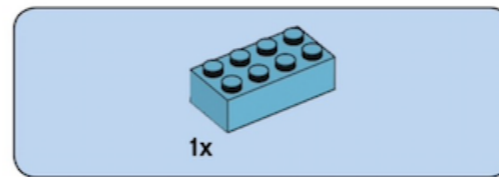

- ◆ 1 brique, 2x2 (noir)
- ◆ 2 briques, 1x2 (bleu azur)

46

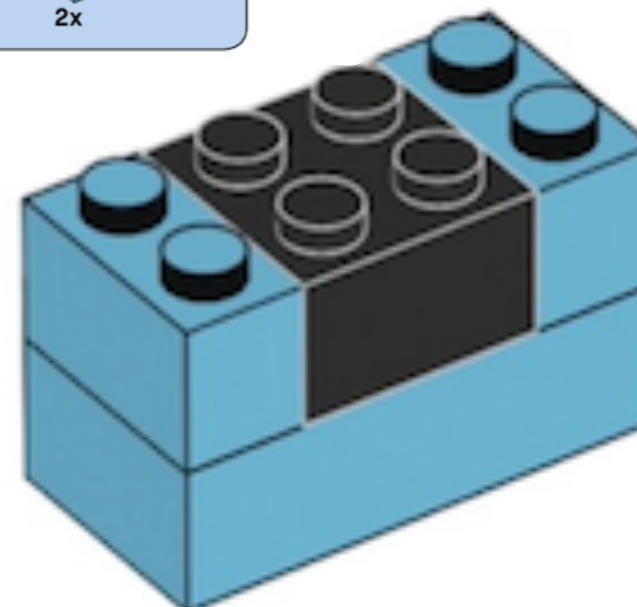
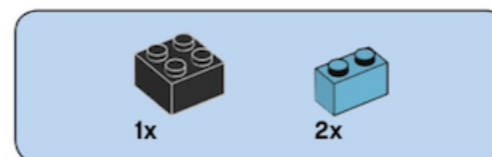

◆ 4 briques inclinées,
1x2x2/3 (orange vif)

47

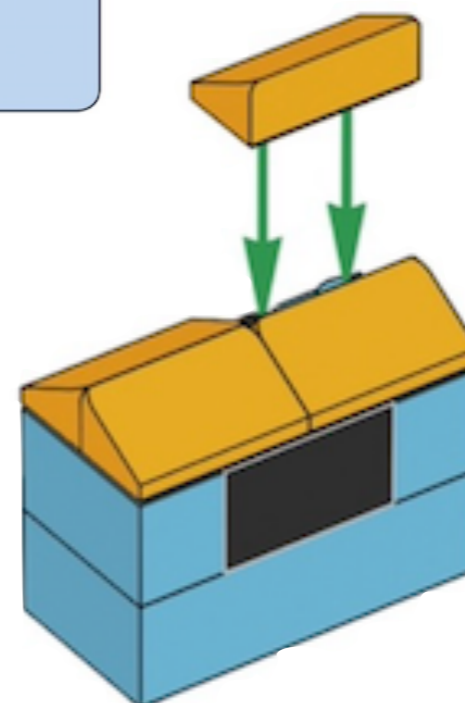

◆ 1 plaque, 1x4 (blanc)

48

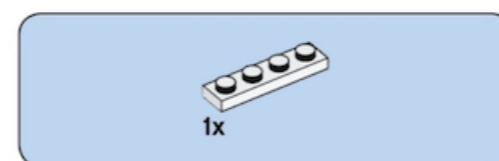

- ◆ 2 briques perforées sur le côté, 1x1 (blanc)
- ◆ 1 brique, 1x2 (bleu azur)

49

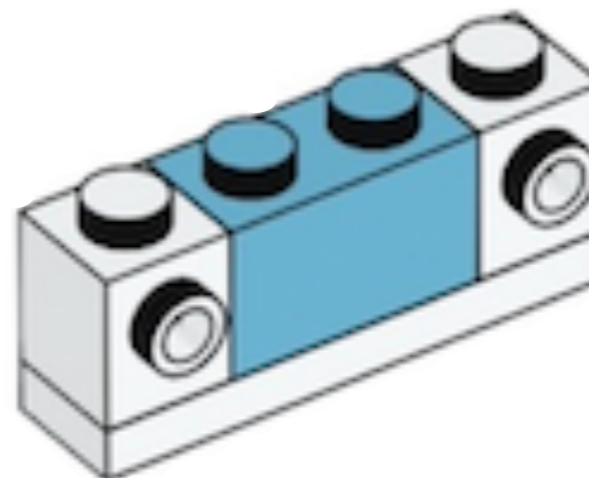
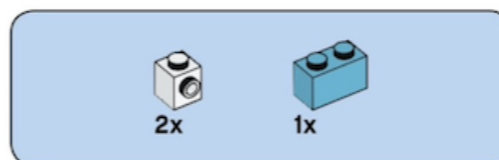

- ◆ 2 plaques rondes, 1x1 (noir)
- ◆ 1 plaque à renvoi d'angle, 1x2/2x2 (blanc)

50

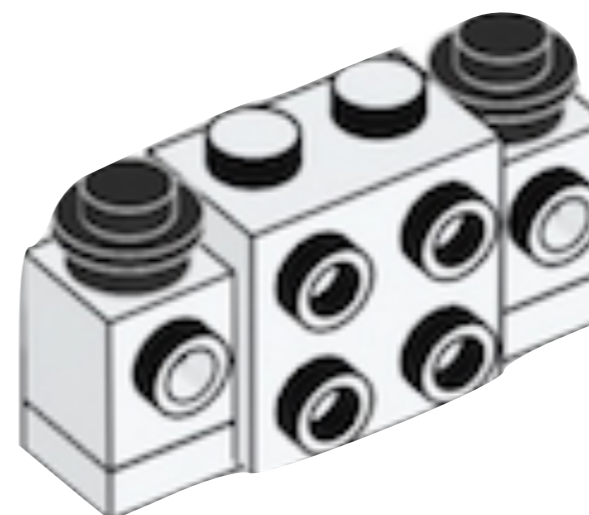
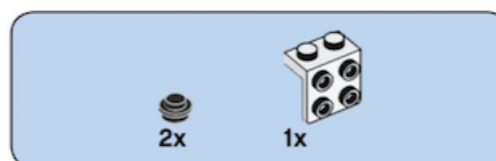

- ◆ 2 tuiles rondes avec oeil, 1x1 (blanc)
- ◆ 1 plaque ronde avec 1 picot, 2x2 (blanc)

51

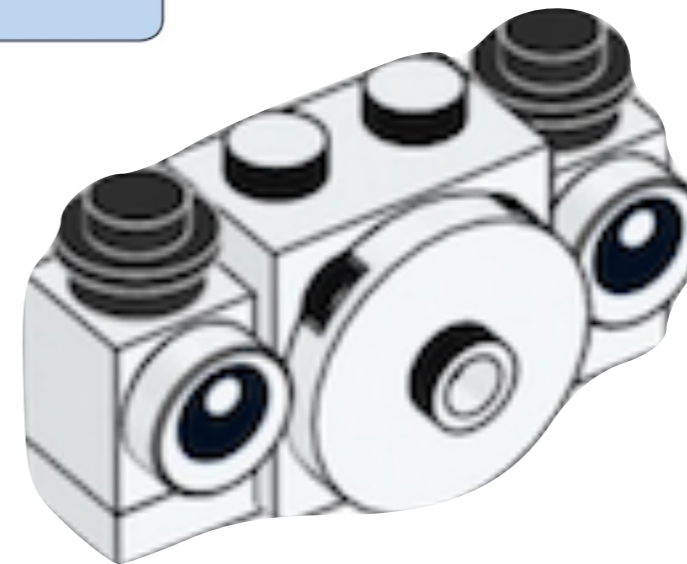
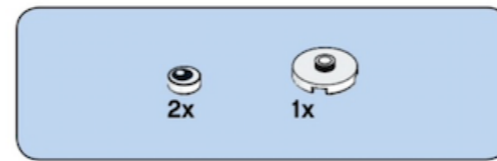

- ◆ 1 plaque ronde, 1x1 (noir)

52

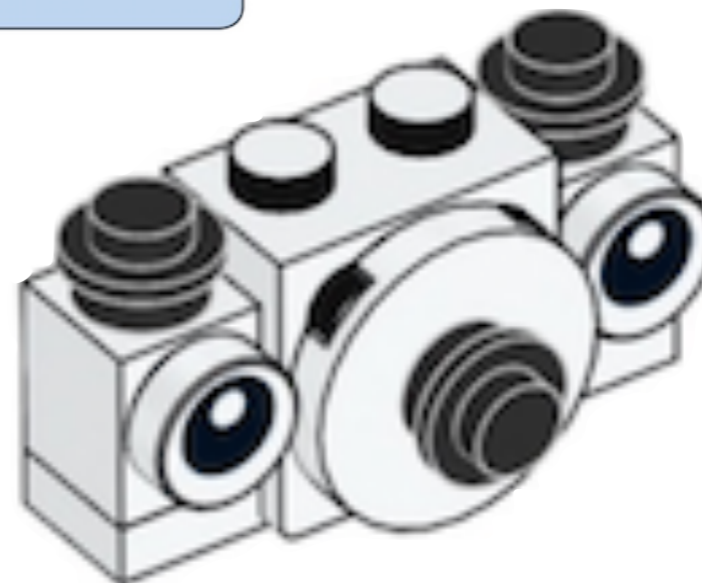
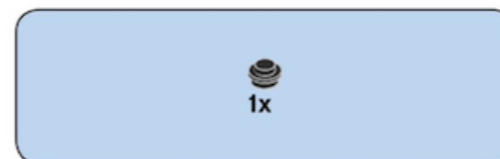

- ◆ 1 brique, 2x2 (noir)
- ◆ 1 plaque, 1x2 (blanc)
- ◆ 2 briques inclinées, 1x2/45° (noir)

53

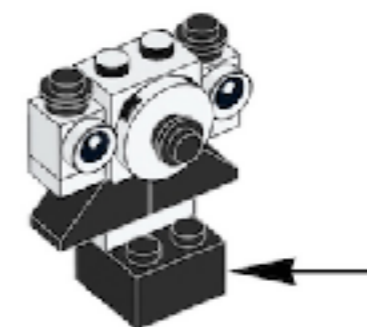
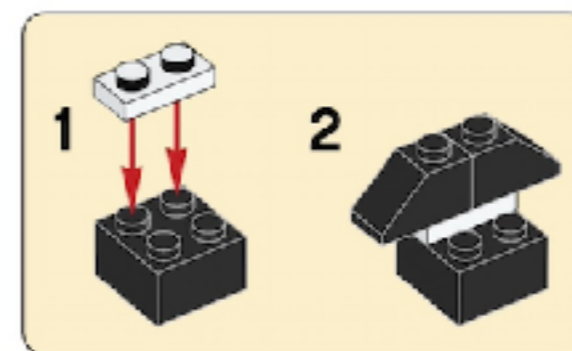
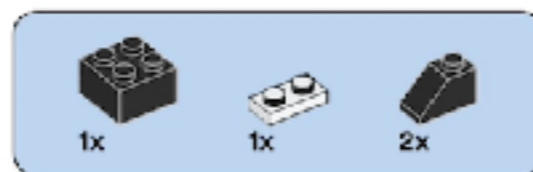

- ◆ 4 briques rondes, 2x2 (bleu clair transparent)

54

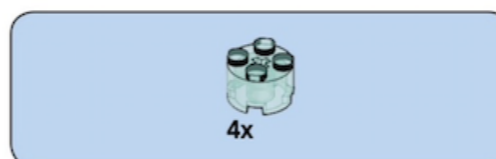

55

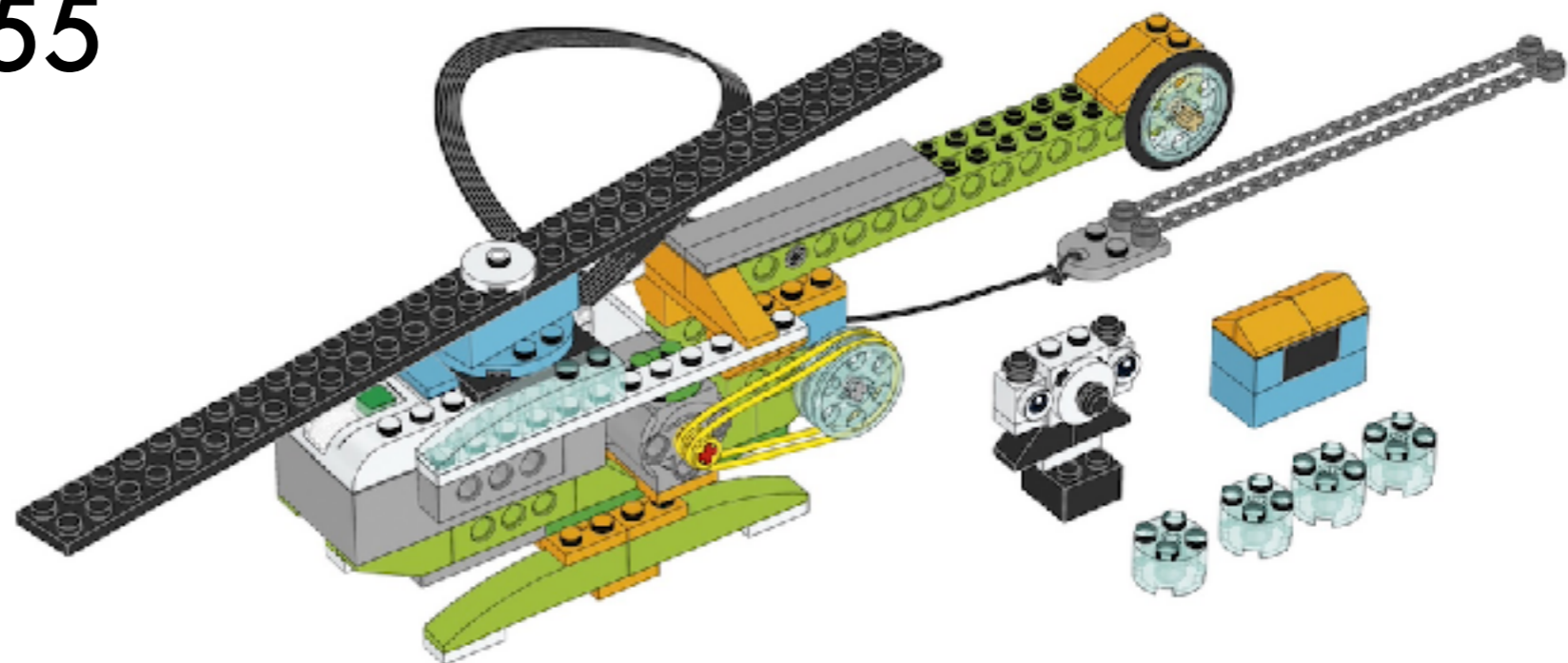

BRAVO!