



# Le gardien de but

## Modèle 8

Source : Plan et images de LEGO Education  
Modification et bonification des plans par le Service national du RÉCIT à l'éducation préscolaire  
Février 2011



2 briques rouges en pente  
2 X 2

1 brique 8 X 16

1 poutre à clavette  
1 X 2

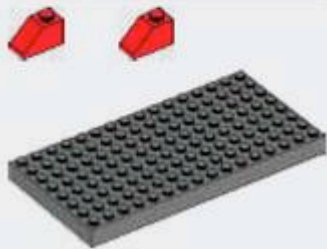

1



2

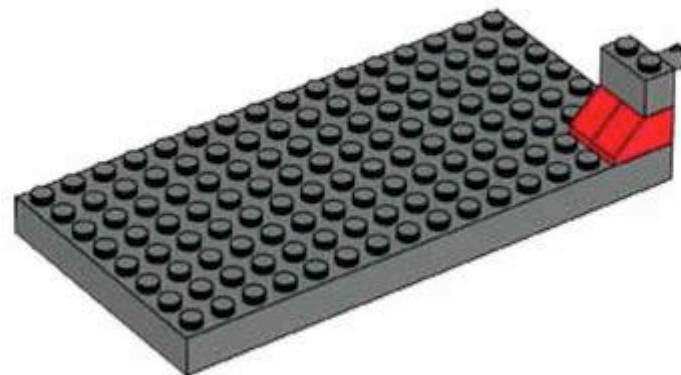

1 poutre plate à 2 modules

1 clavette à friction



3

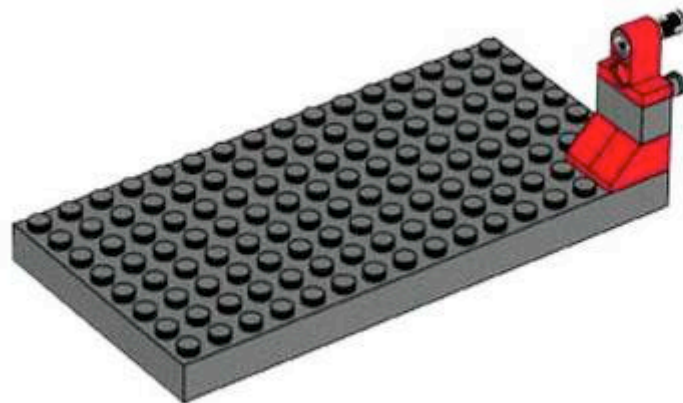

4

1 mini concentrateur USB

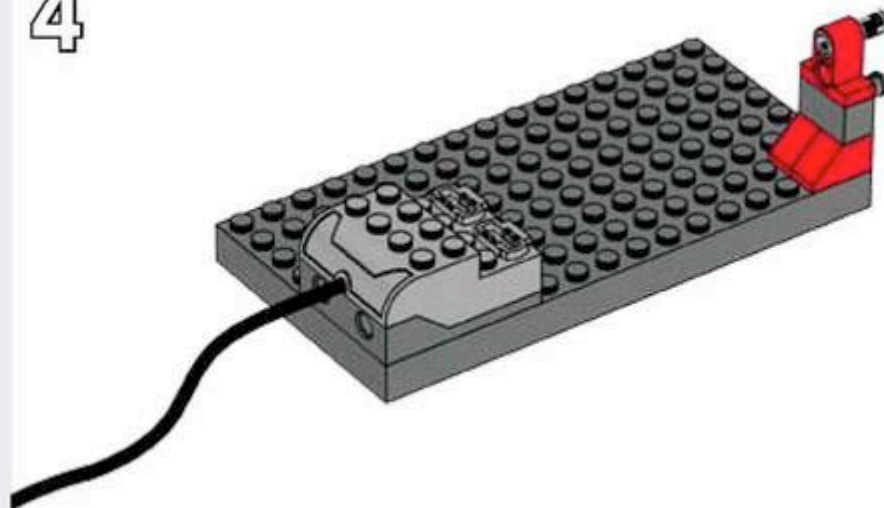

1 arbre cruciforme  
(grandeur 3)

1 moteur

2 clavettes à friction



5

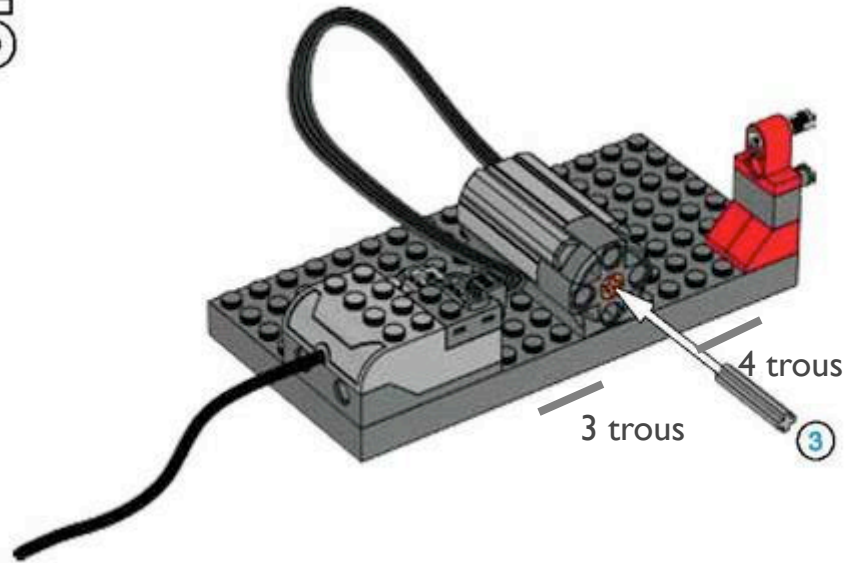

6

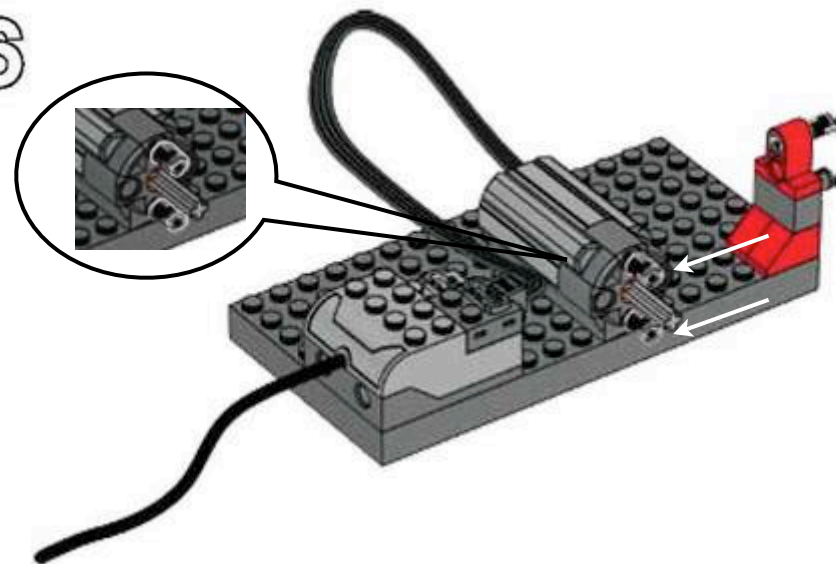

1 plaque 2 X 4

1 poutre rouge 2 X 2



7

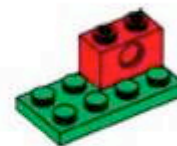

1 poutre rouge 1 X 8



8

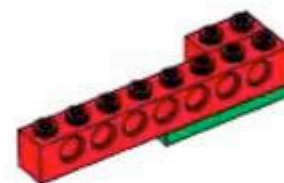

1 plaque 2 X 4



9

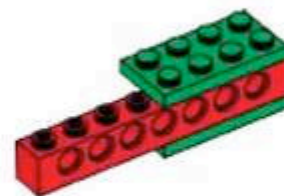

10

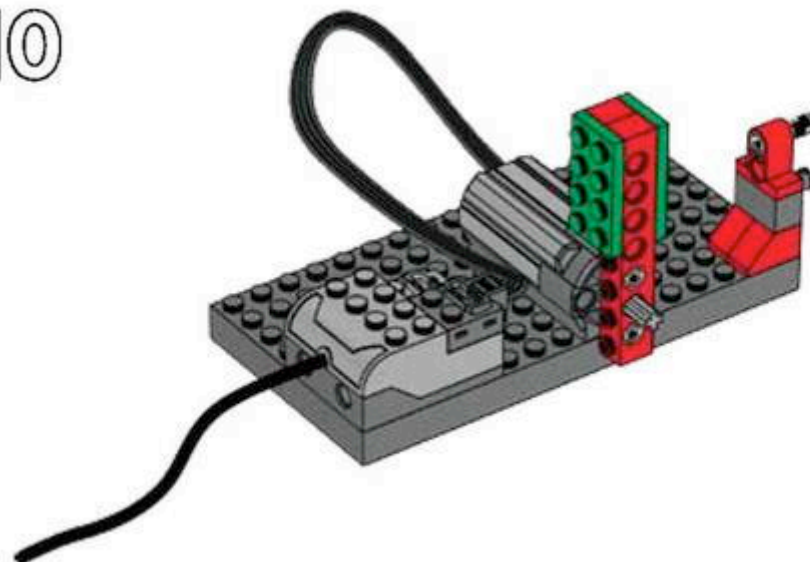
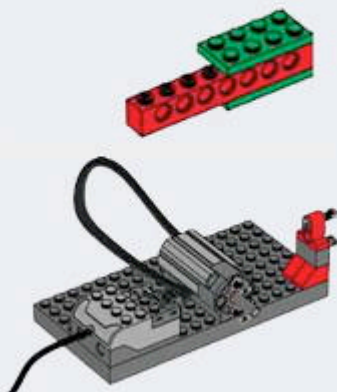

1 arbre cruciformé  
(grandeur 6)

1 manchon

1 grande poulie



11



12

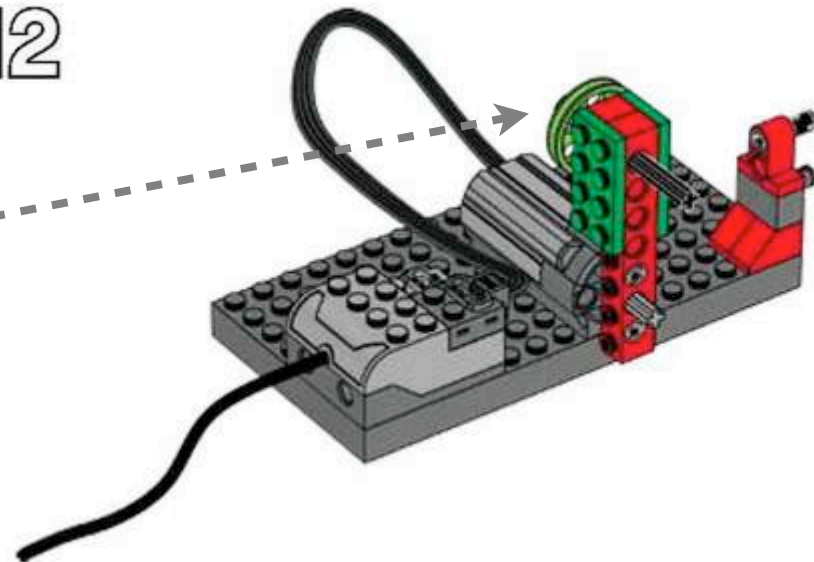
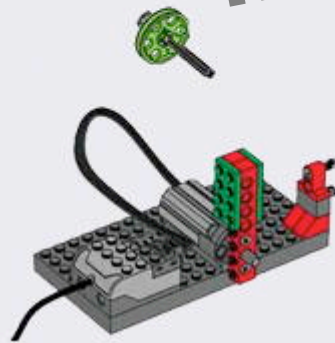

2 manchons  
1 grande poulie



13

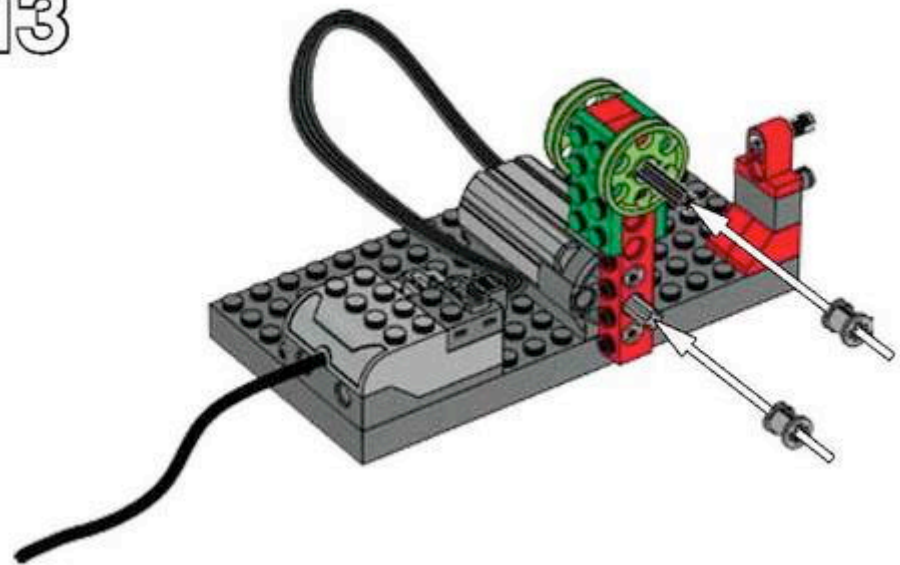

1 courroie



14

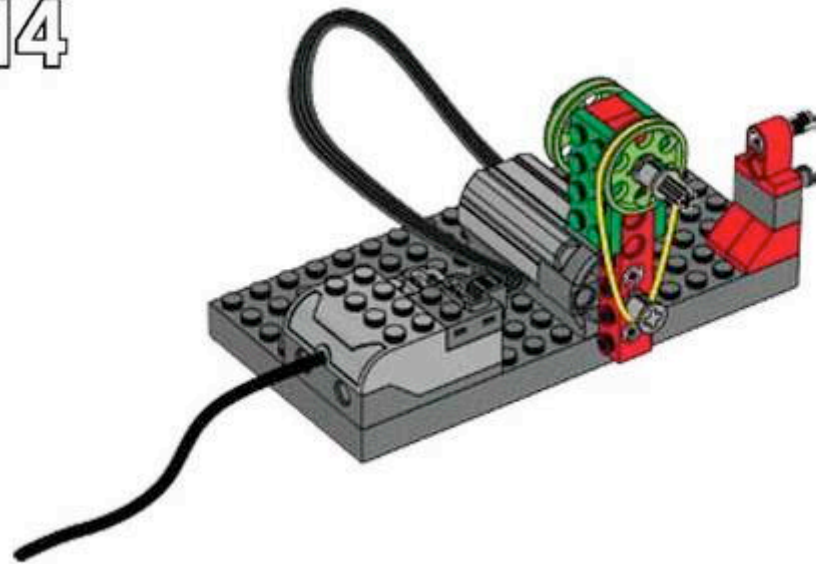



2 plaques 2 X 8

1 poutre rouge 1 X 16



2 briques rouges 2 X 4



15

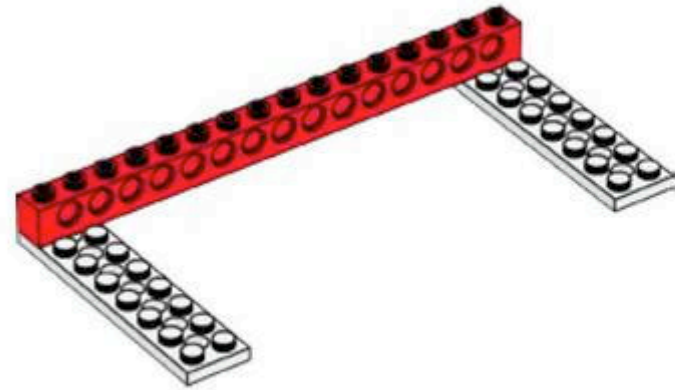

16

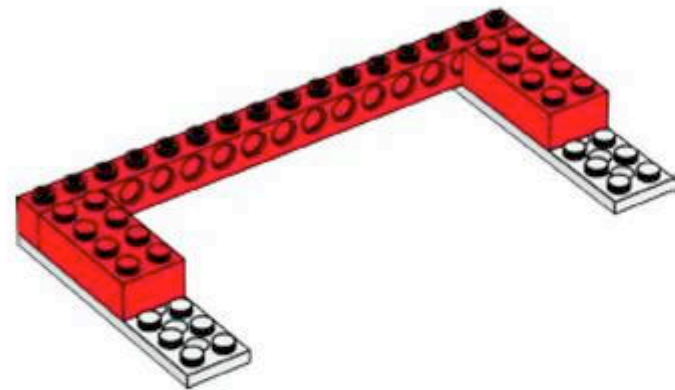

2 poutres rouges 1 X 6

1 brique rouge  
en pente 2 X 6

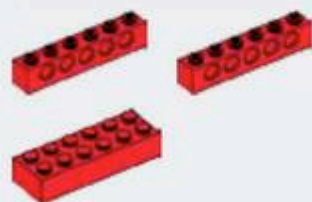

17

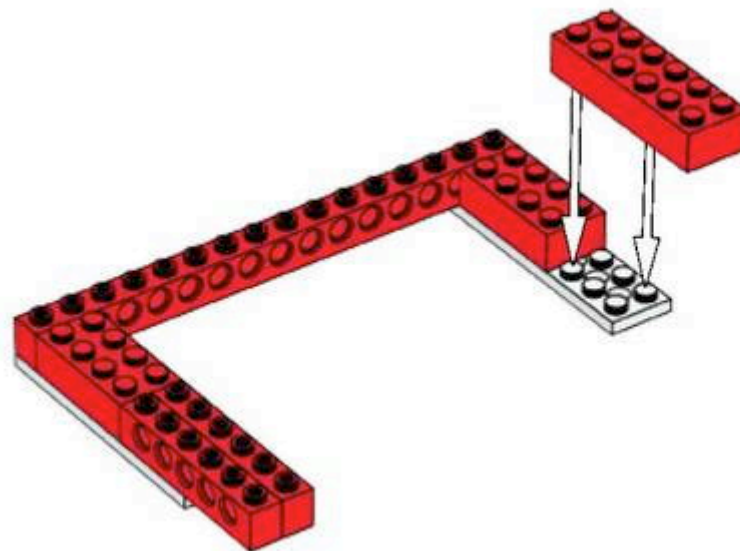

18

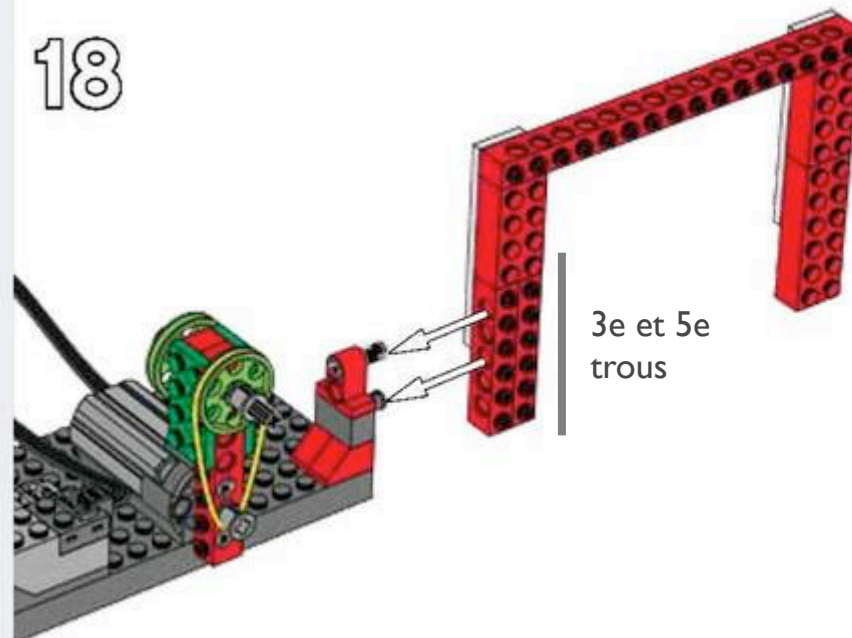
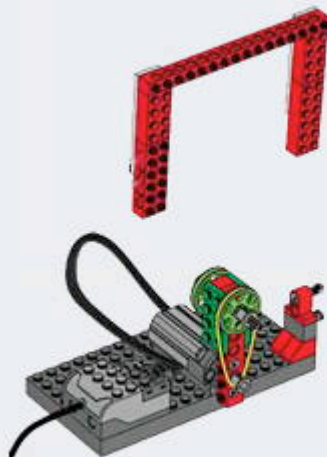

1 poutre rouge 1 X 2

1 plaque 1 X 8



19



3 poutres grises 1 X 2



20

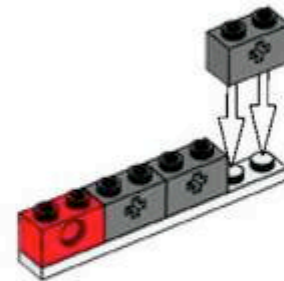

1 plaque 1 X 8

21

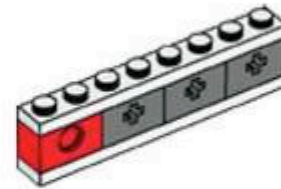

22

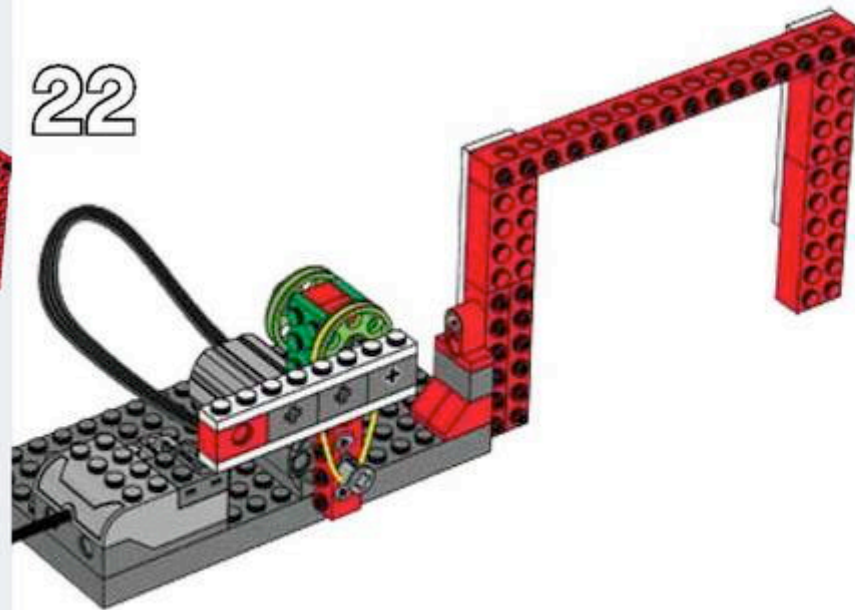
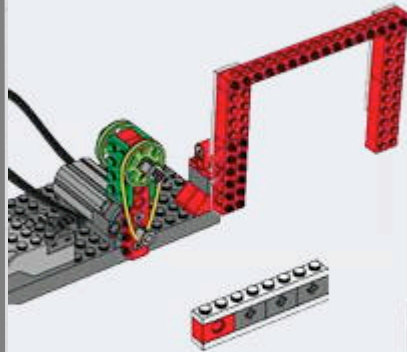

1 plaque 1 X 8

1 plaque 1 X 4



23

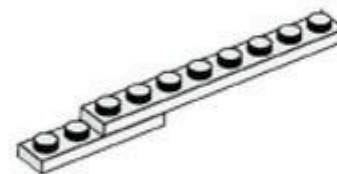

24

1 plaque 1 X 8

1 plaque 1 X 4

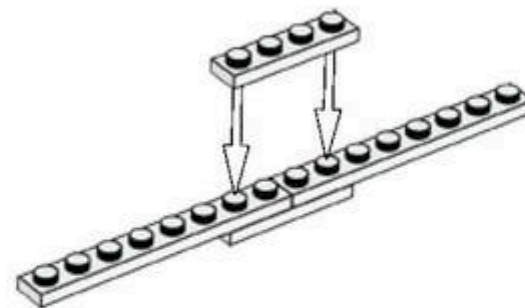

1 poutre plate à deux modules

1 poutre à clavette



25

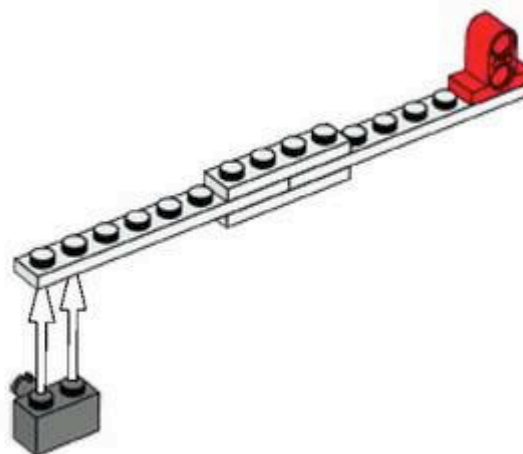

26

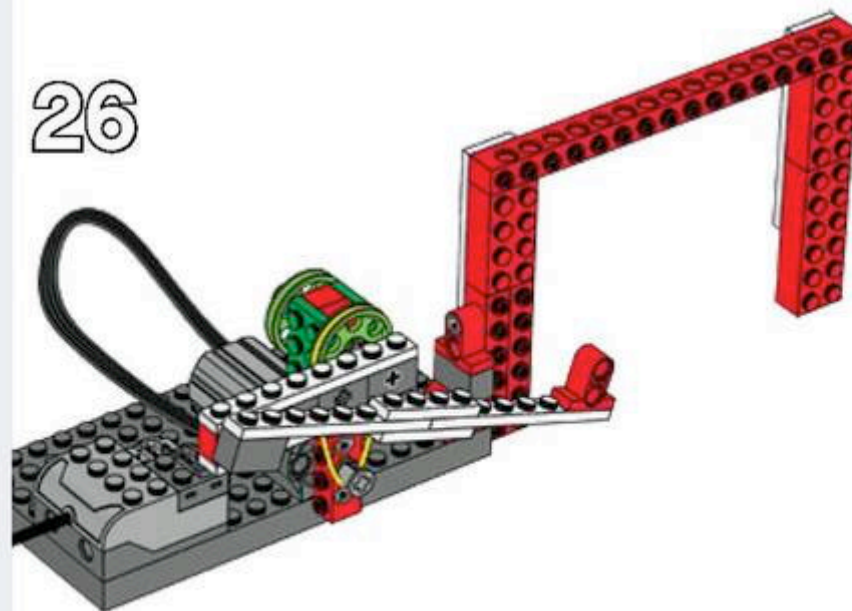
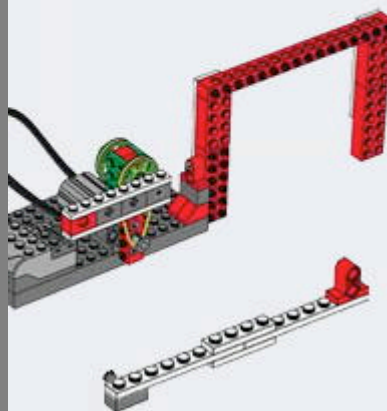



27

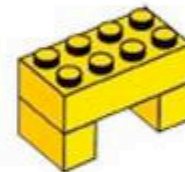

1 brique jaune 2 X 4  
2 poutres jaunes 1 X 2

28

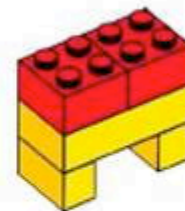

2 briques rouges 2 X 2

1 poutre à clavette



29

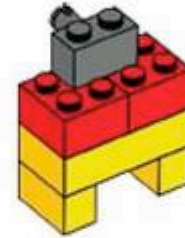

2 poutres rouges  
de charnière



30

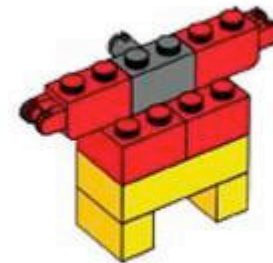

2 poutres jaunes  
de charnière



1 poutre rouge 1 X 4



31

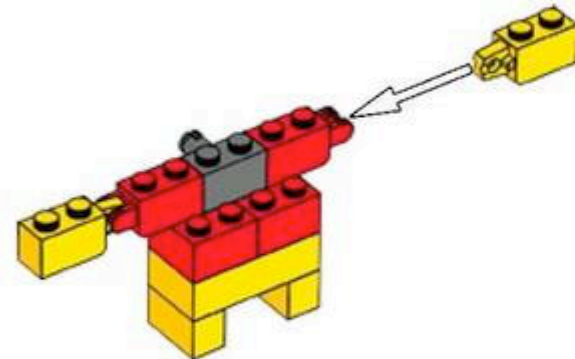

32

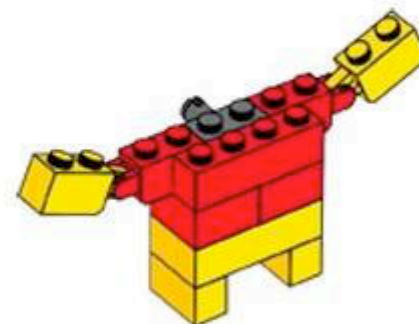

I plateforme tournante



33

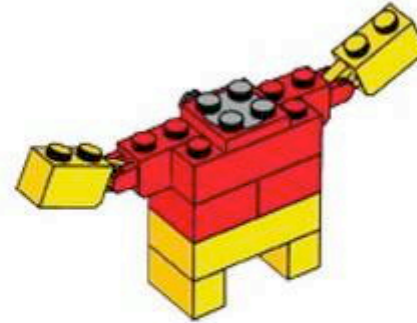

I brique jaune 2 X 4



34

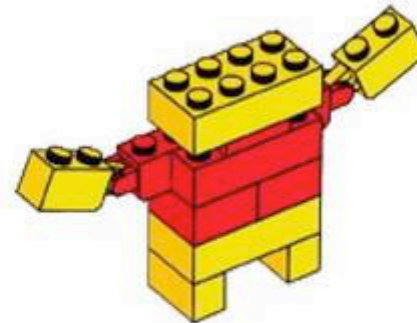

1 poutre jaune 1 X 4

1 brique en pente 2 X 2



35

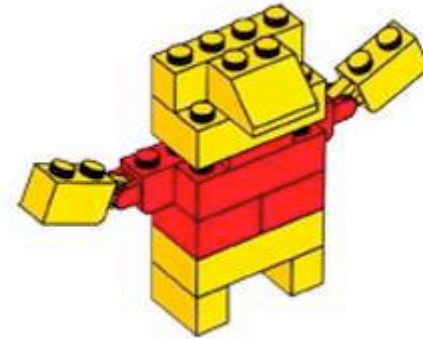

2 poutres 1 X 1

1 plaque 2 X 4



36

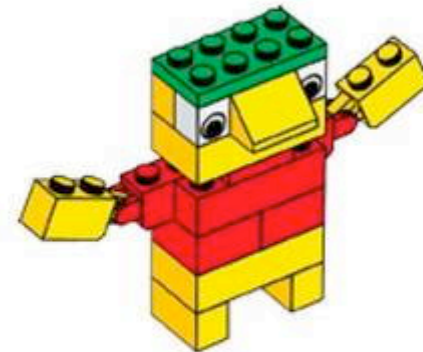

2 briques rouges  
en pente 2 X 2



2 glisseurs



37

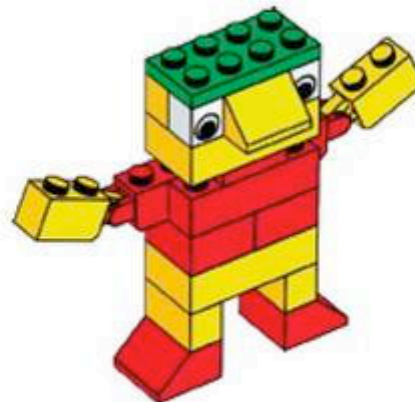

38

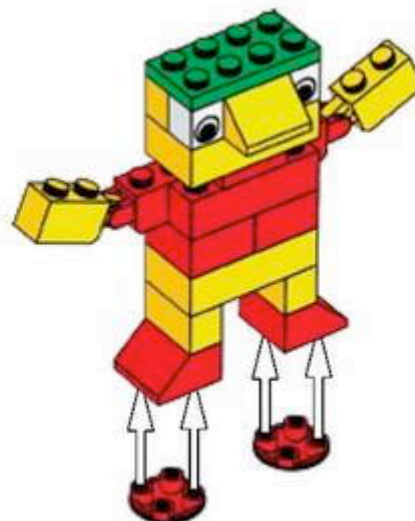

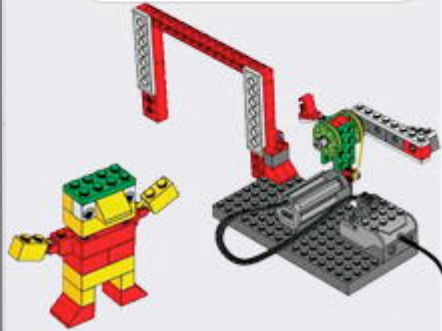

39



40

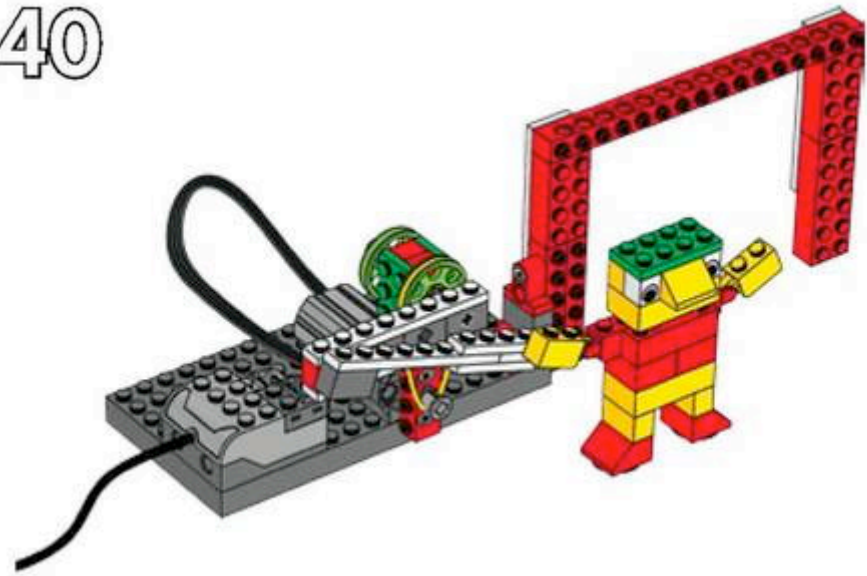

41

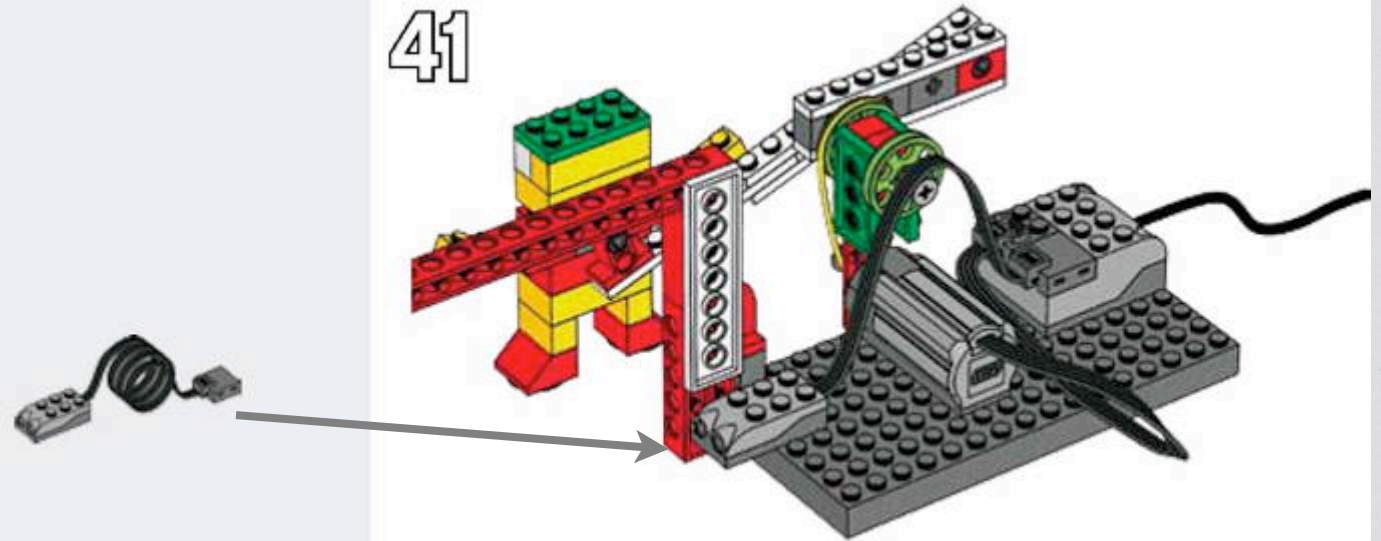

42

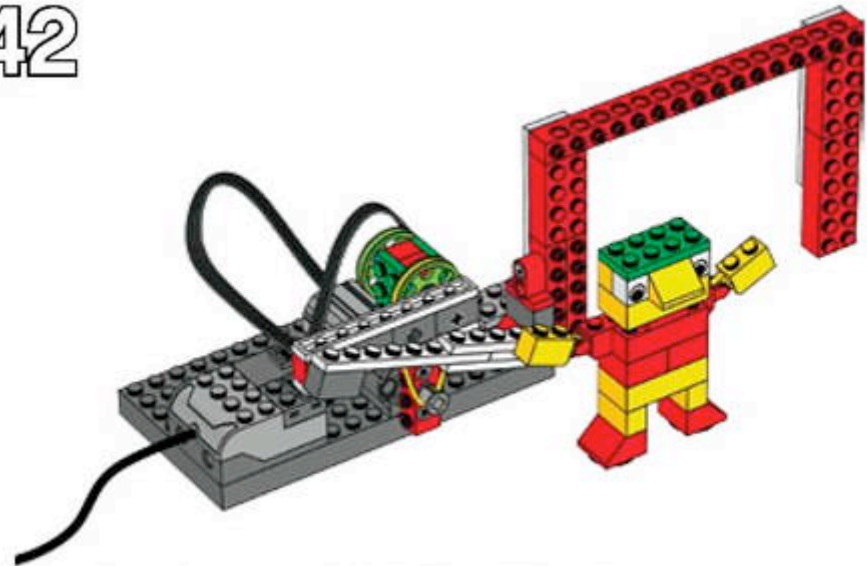

LEGO, the LEGO logo and WEDO are trademarks of the/son des marques de commerce de/son marcas registradas de LEGO Group. ©2008 The LEGO Group.

Bravo!