

Pince

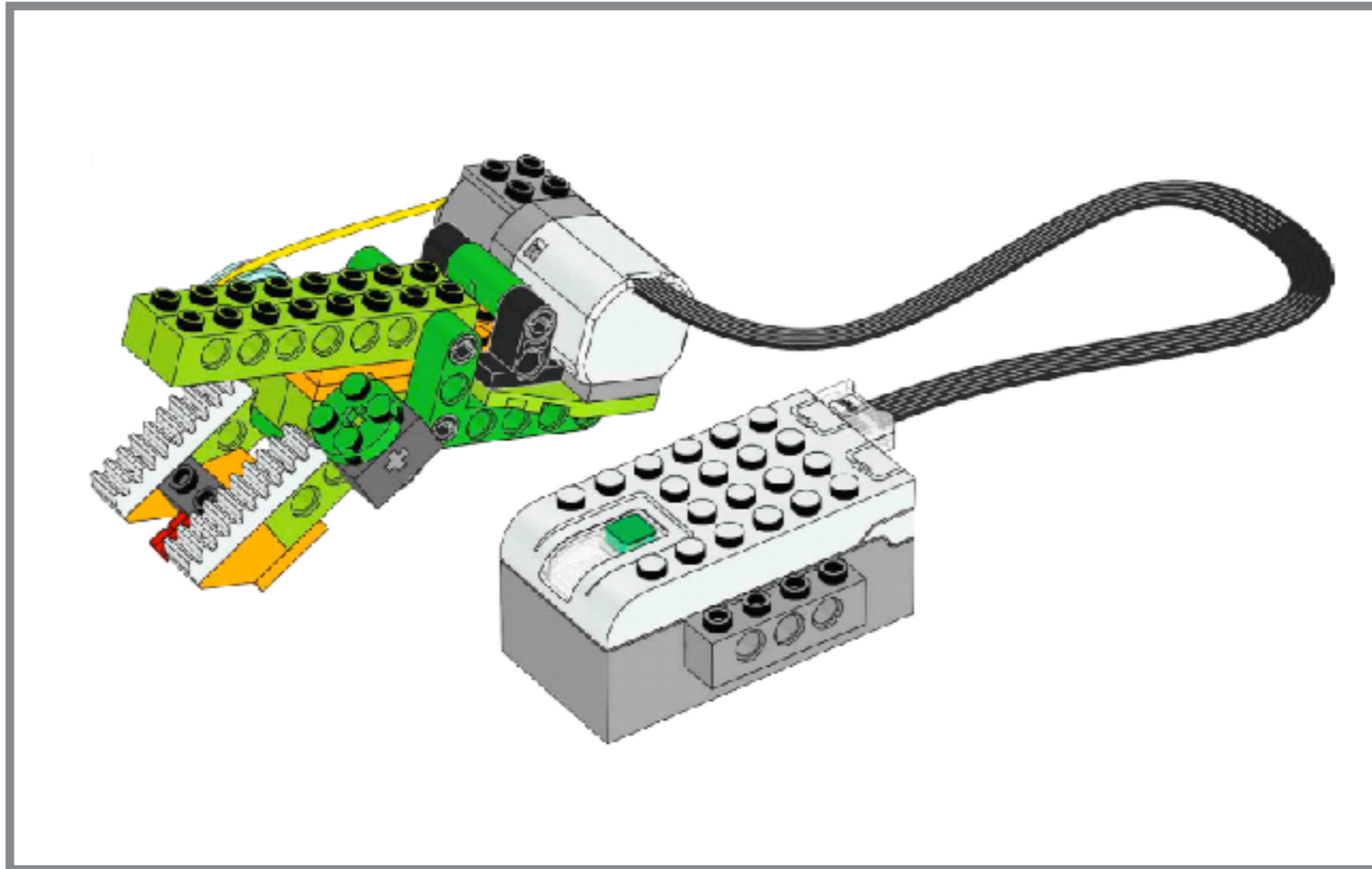

WeDo 2.0 de LEGO Education

Modification et bonification des plans par le Service national du RÉCIT à l'éducation préscolaire

Lynda O'Connell, conseillère pédagogique en TIC et Isabelle Therrien, enseignante à l'éducation préscolaire



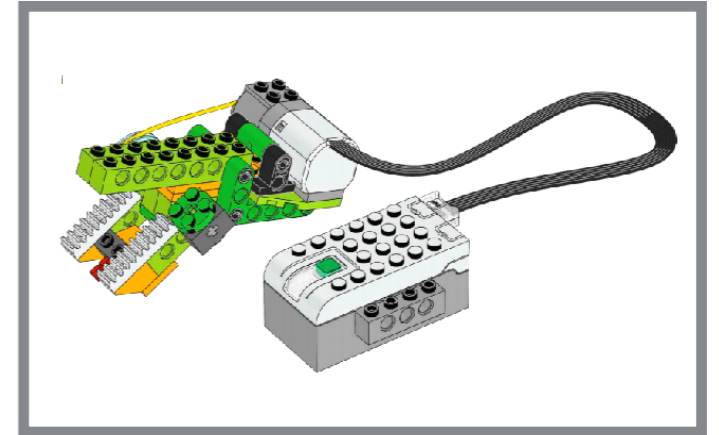

Nombre d'étapes : 29

Nom original du modèle : Grab

Remarque : Aucun capteur dans ce modèle

INVENTAIRE DES PIÈCES

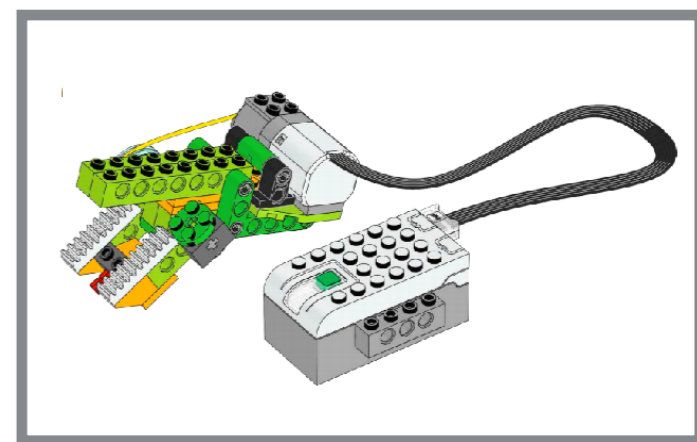
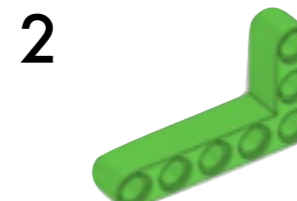
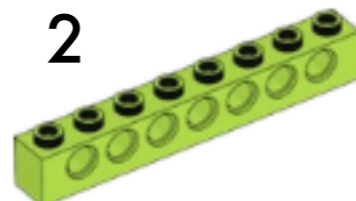
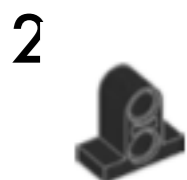
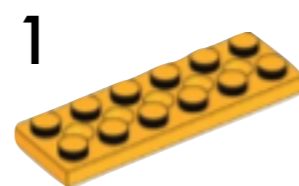
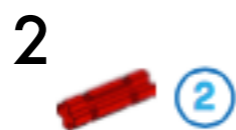
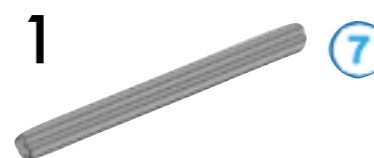
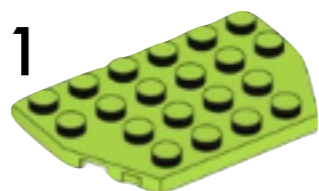
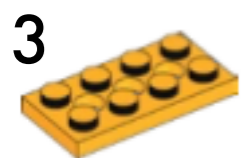
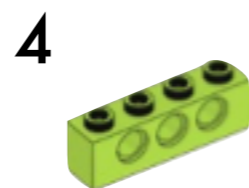
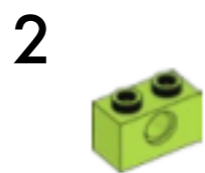
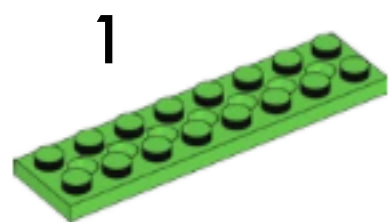

- ◆ 1 brique avec support de bille, 2x2 (bleu clair transparent)
- ◆ 1 plaque percée, 2x8 (vert vif)

1

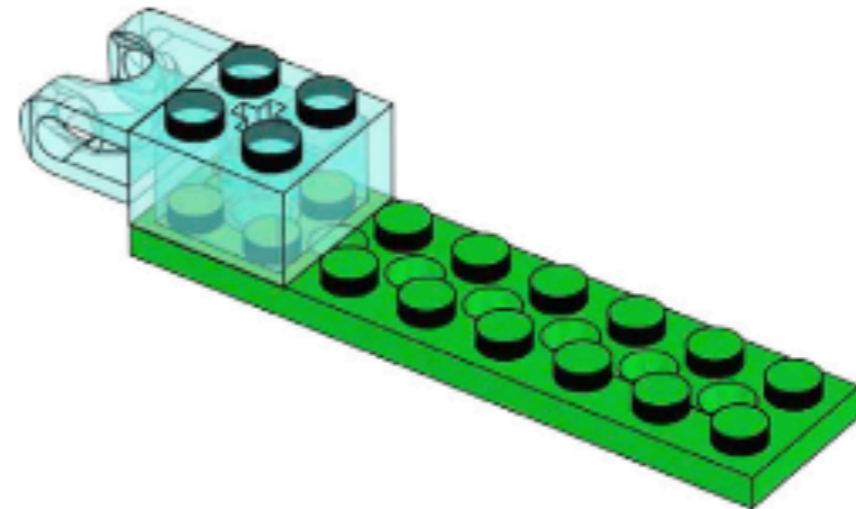
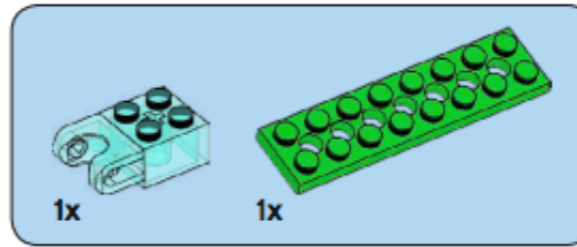

- ◆ 1 poutre perforée avec trou en croix, 1x2 (gris foncé)
- ◆ 1 poutre perforée, 1x2 (vert citron)

2

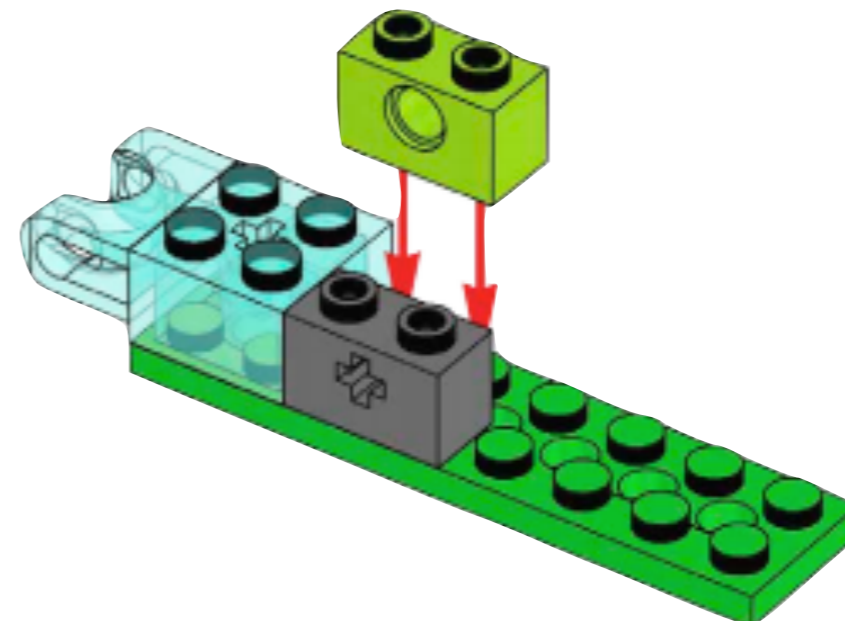
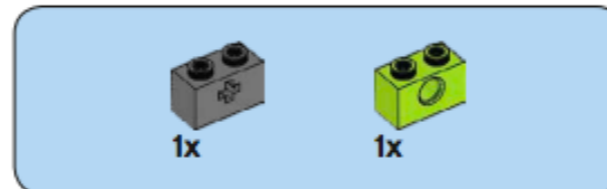

- ◆ 2 poutres perforées,
1x4 (vert citron)

3

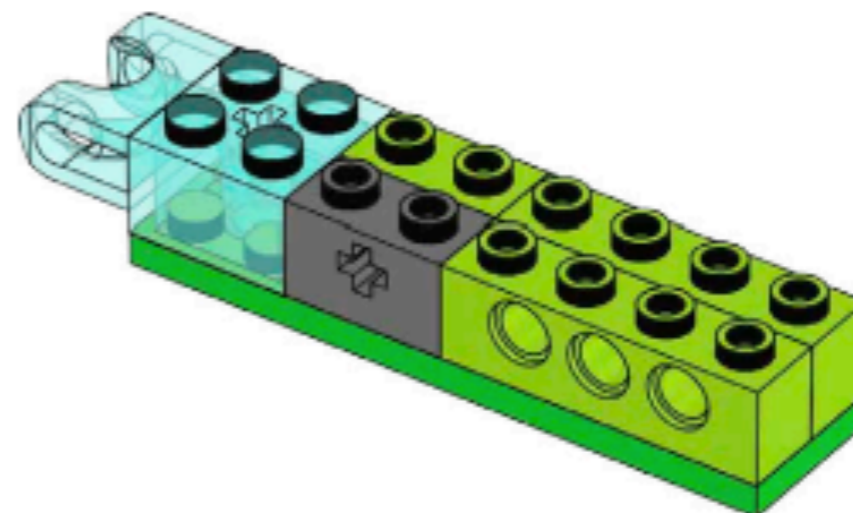
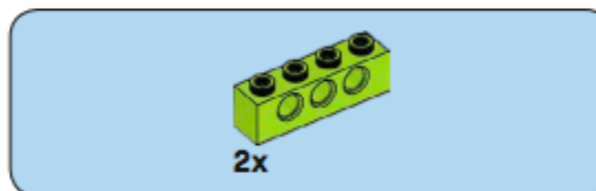

- ◆ 1 plaque 4x6/4 (vert citron)

- ◆ 1 plaque percée, 2x4 (orange vif)

4

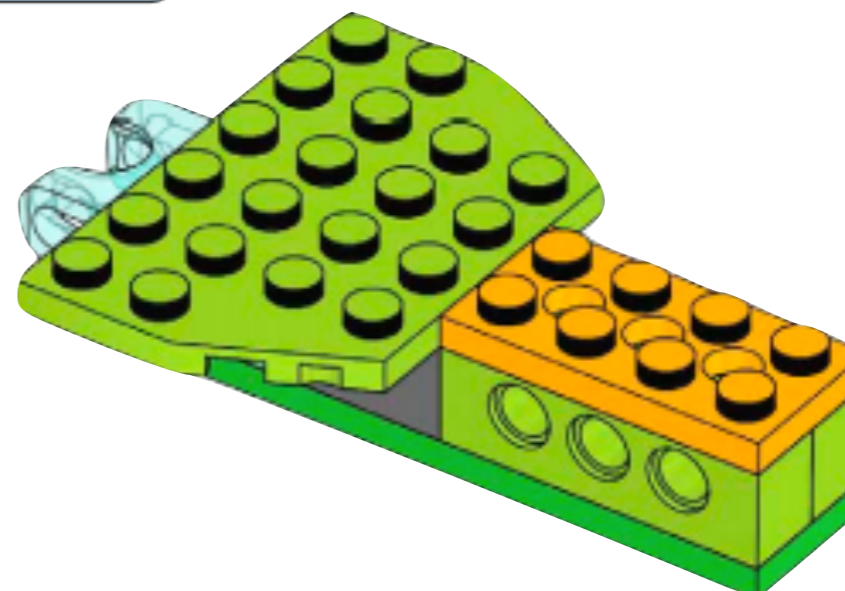
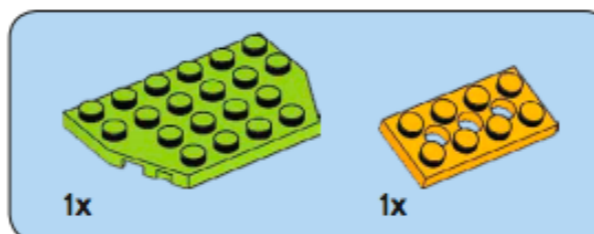

- ◆ 2 chevilles à friction, 2 modules (noir)

5

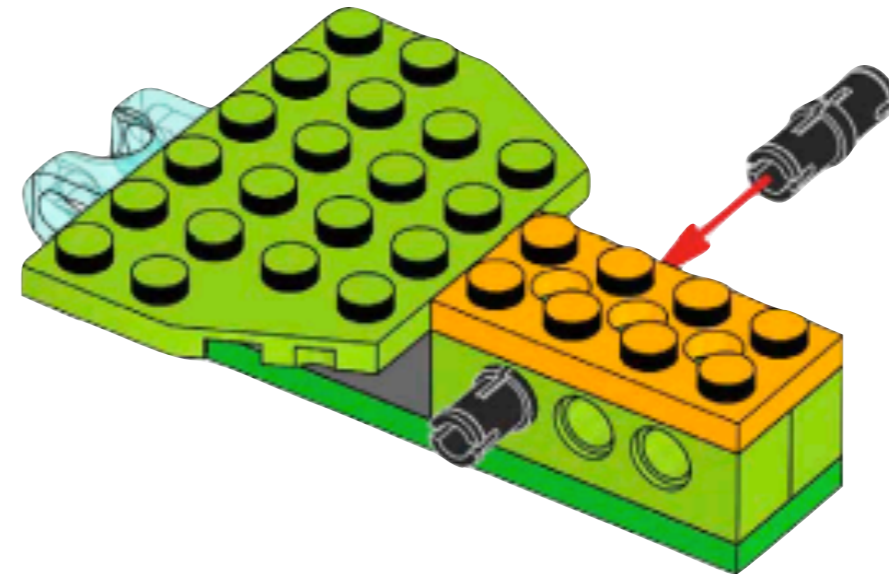

- ◆ 1 poutre perforée avec trou en croix, 1x2 (gris foncé)
- ◆ 1 axe, 7 modules (gris)

6

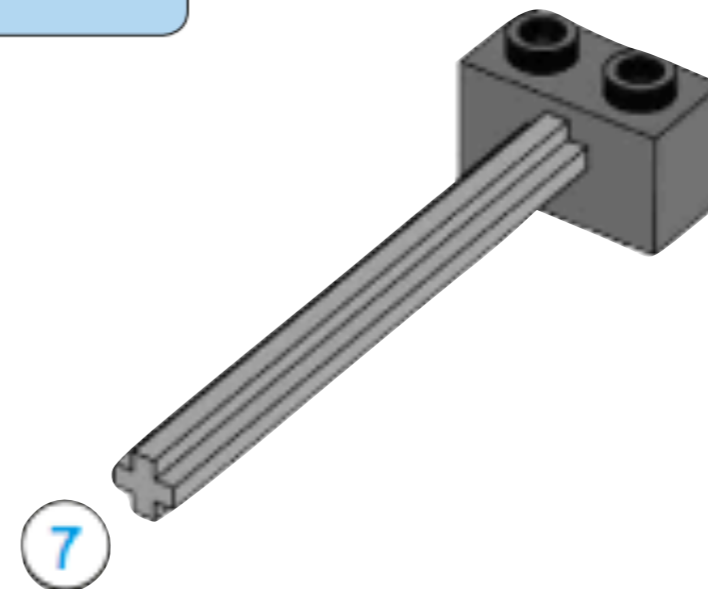
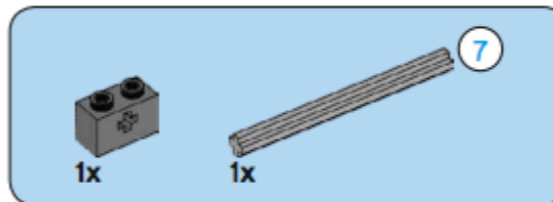

- ◆ 1 poutre perforée, 1x4
(vert citron)

7

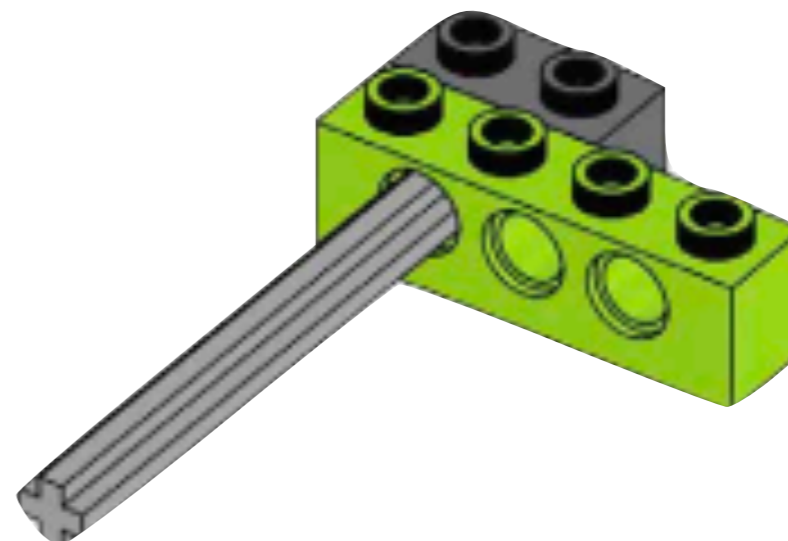
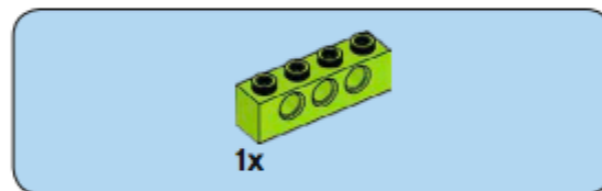

- ◆ 1 plaque ronde, 2x2
(vert vif)

8

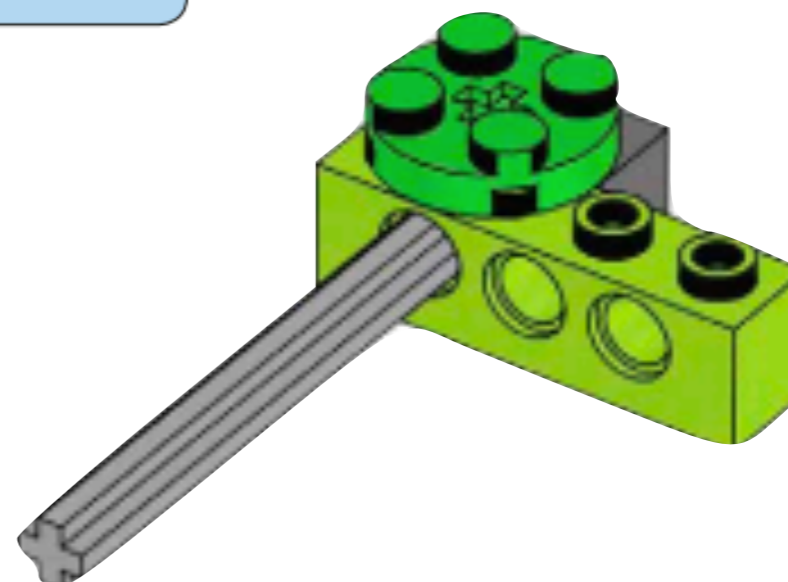

◆ 1 plaque de protection,
2x2 (noir)

9

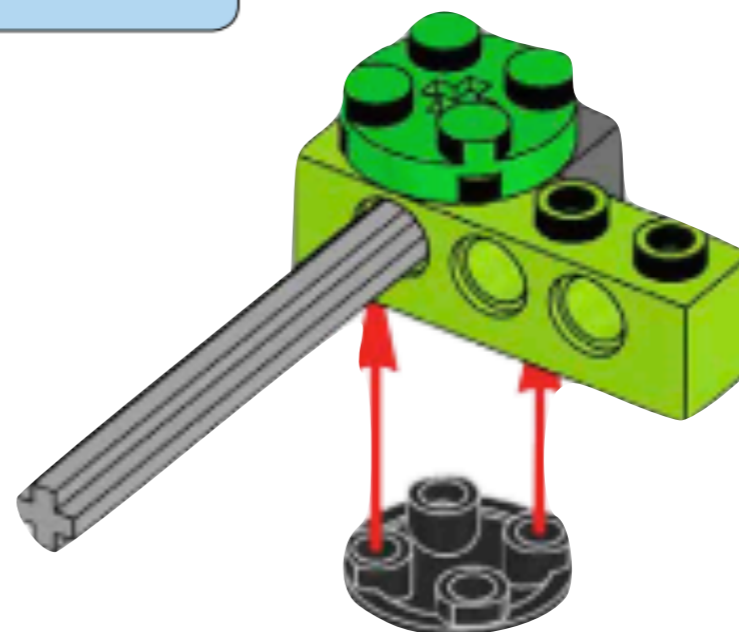

10

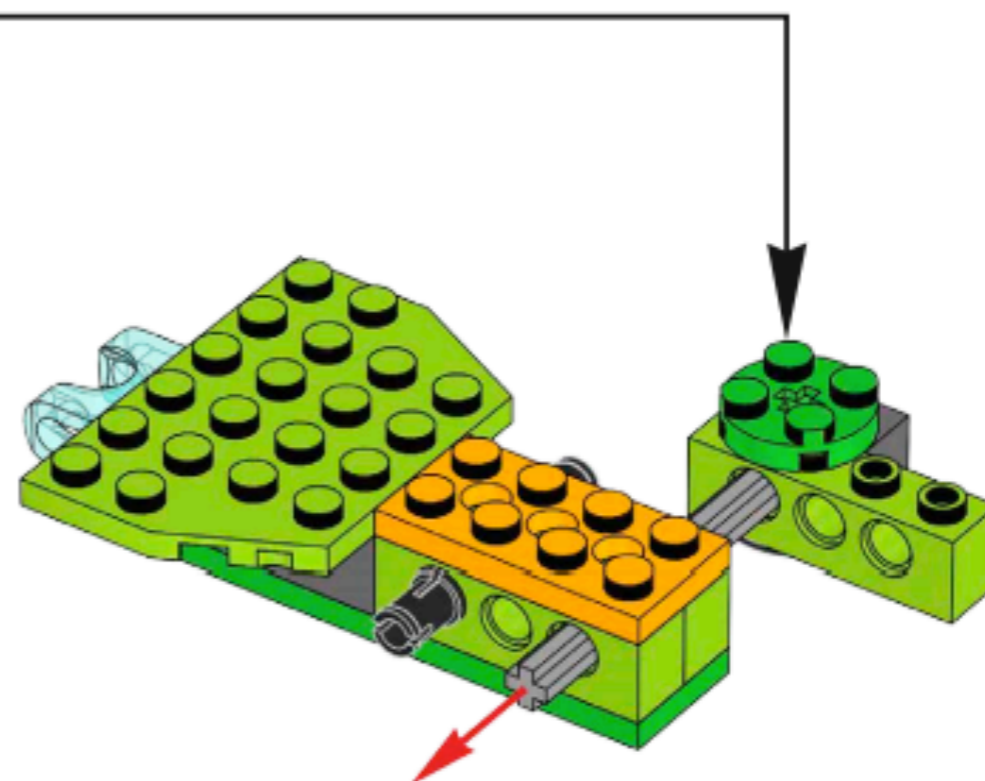

- ◆ 1 plaque de protection (noir)
- ◆ 1 poutre perforée, 1x4 (vert citron)

11

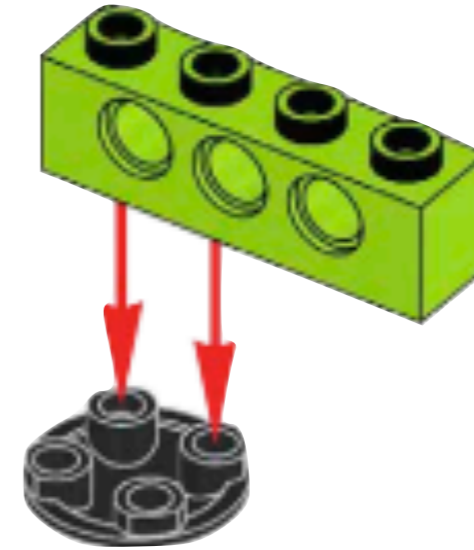
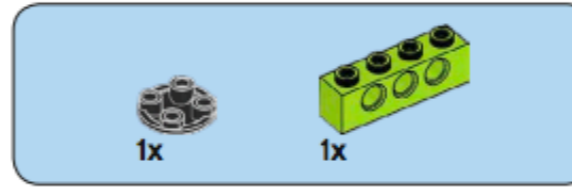

- ◆ 1 poutre perforée avec trou en croix, 1x2 (gris foncé)

12

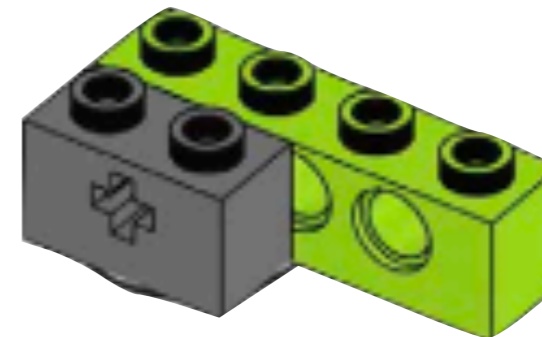
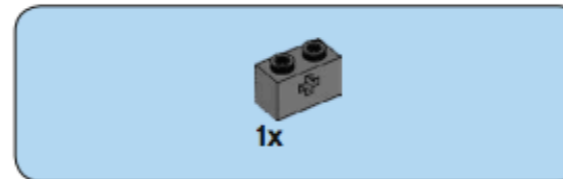

◆ 1 plaque ronde, 2x2
(vert vif)

13

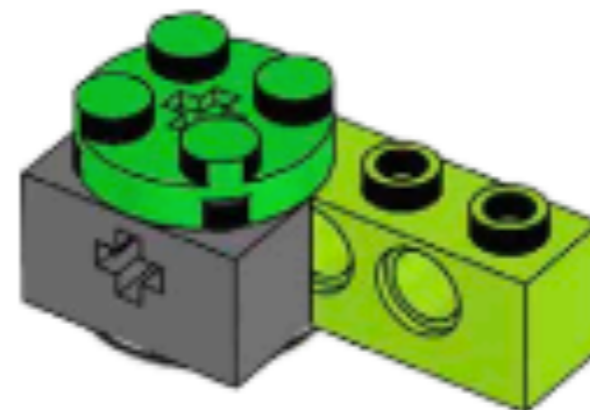

14

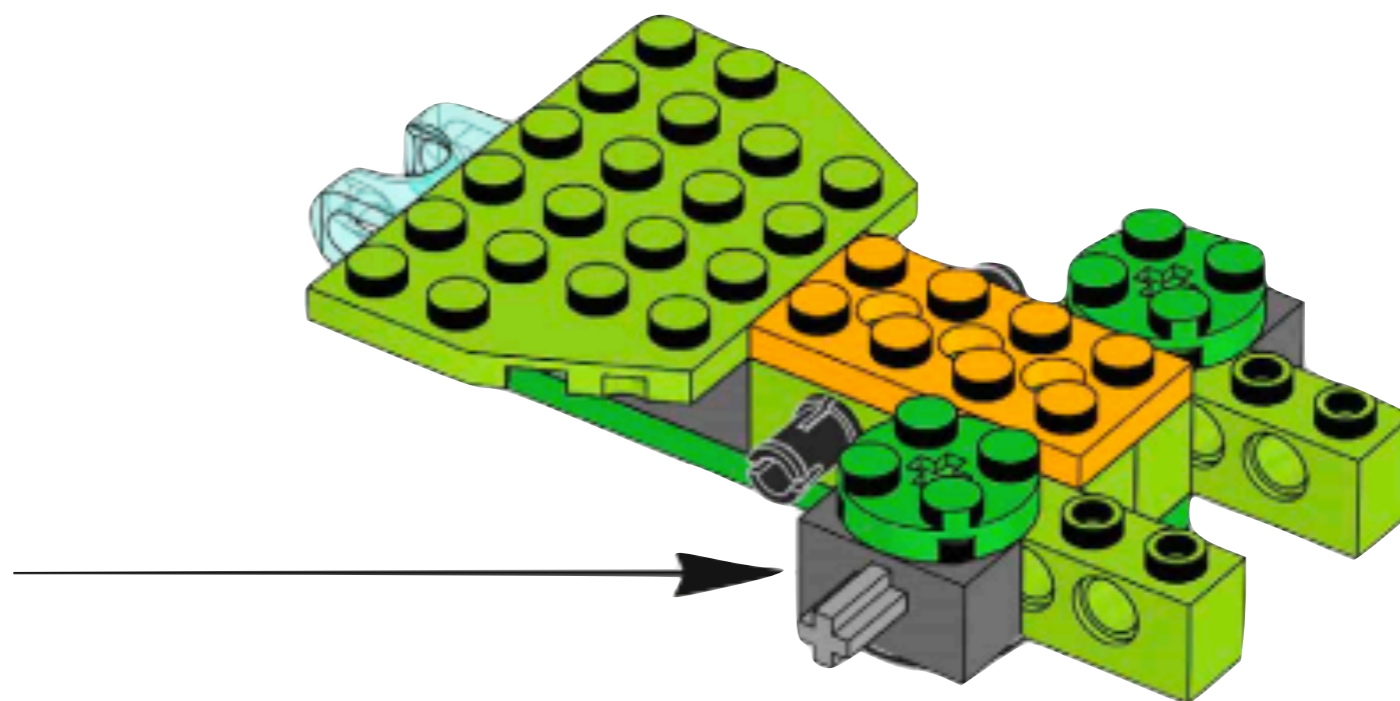

- ◆ 1 brique inclinée, 1x2x2/3 (orange vif)
- ◆ 1 plaque percée, 2x4 (orange vif)

15

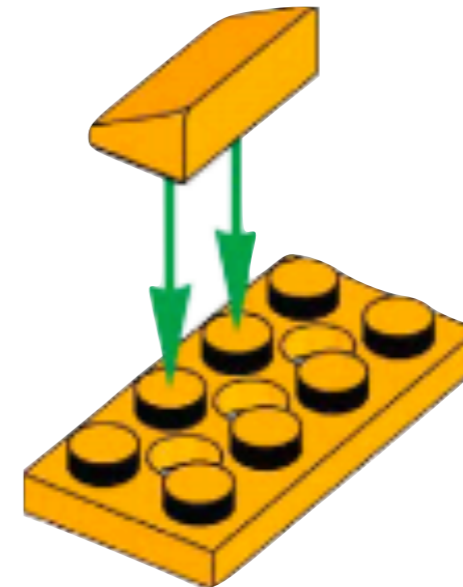
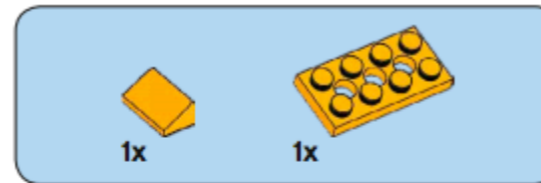

- ◆ 1 axe, 2 modules (rouge)
- ◆ 1 poutre perforée avec trou en croix, 1x2 (gris foncé)

16

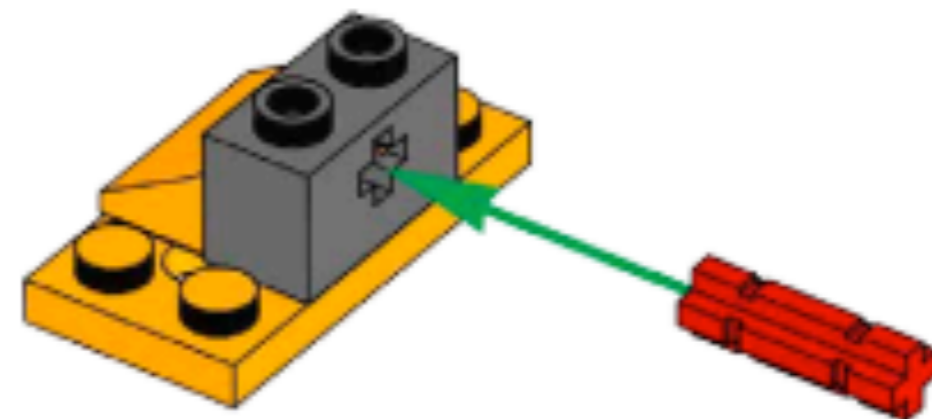
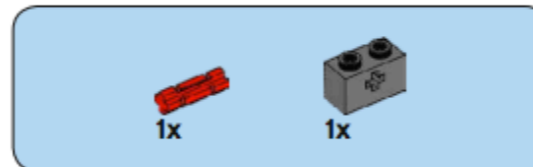

◆ 2 briques inclinées
inversées, 1x2/45°
(orange vif)

17

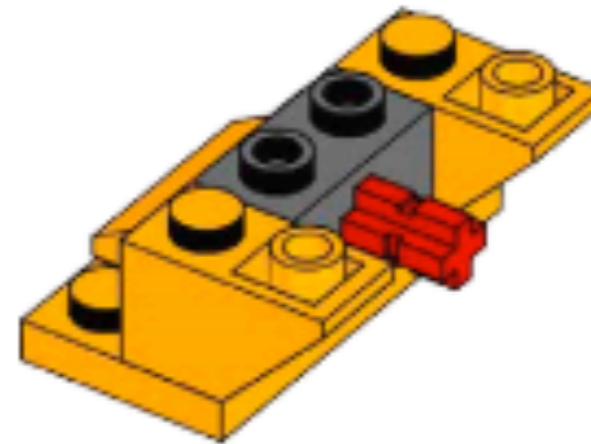

18

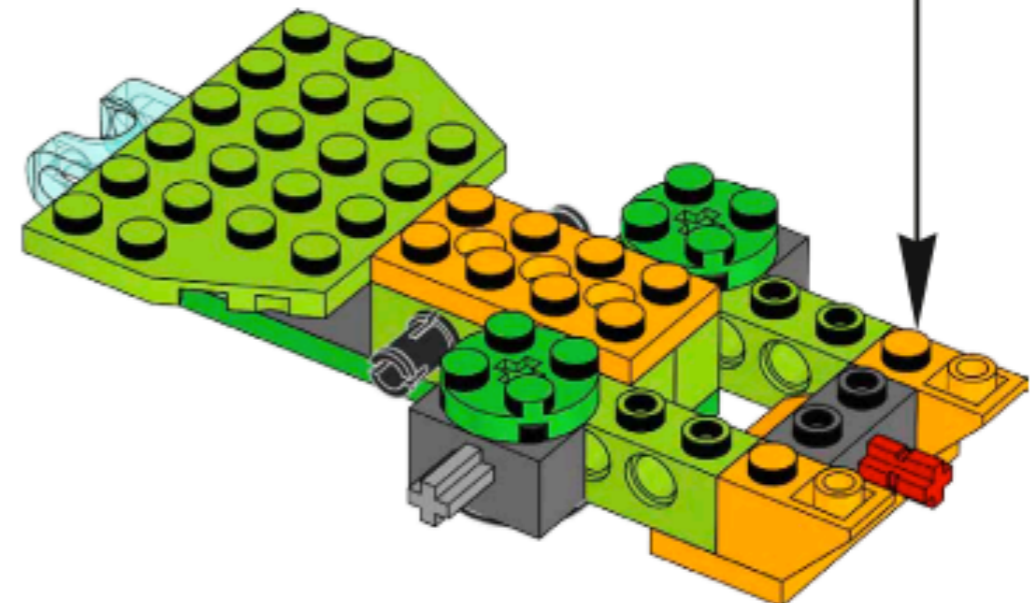

- ◆ 2 crémaillères, 10 dents (blanc)
- ◆ 1 plaque percée, 2x6 (orange vif)

19

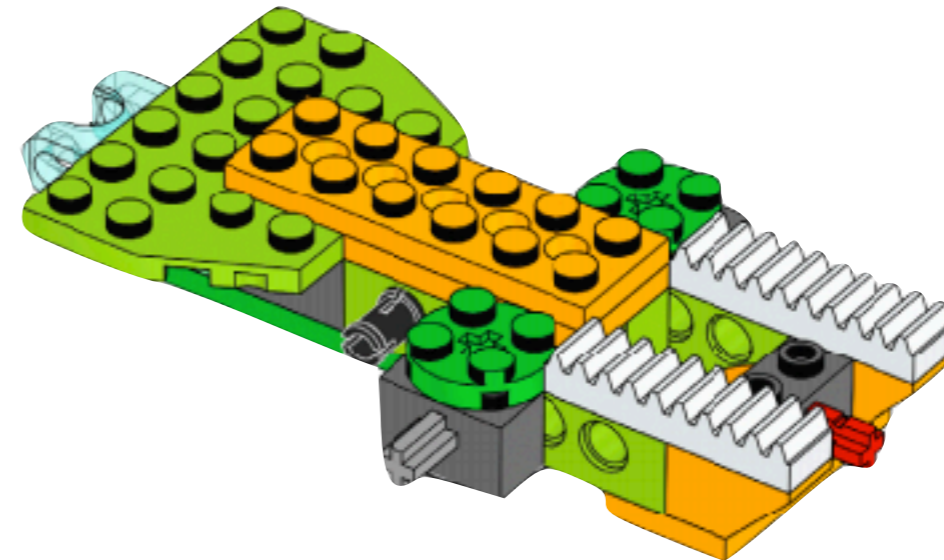
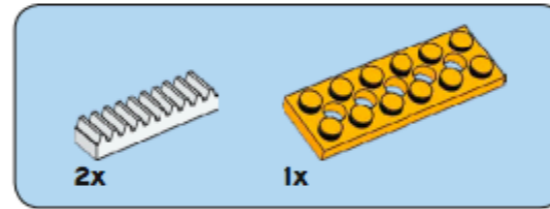

- ◆ 2 chevilles à friction, 2 modules (noir)
- ◆ 2 poutres avec plaque, 2 modules (noir)
- ◆ 1 tube, 2 modules (vert vif)

20

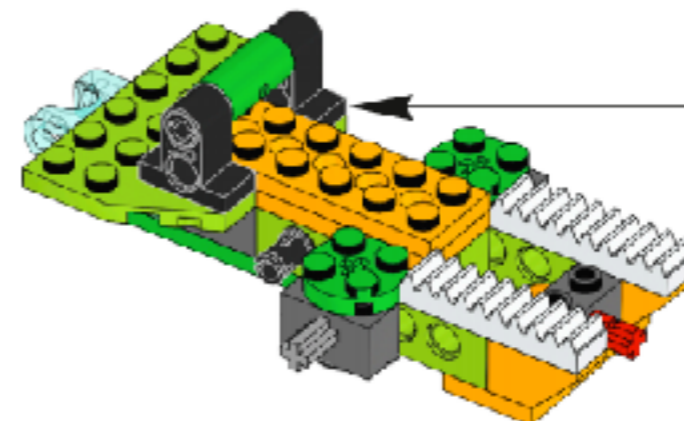
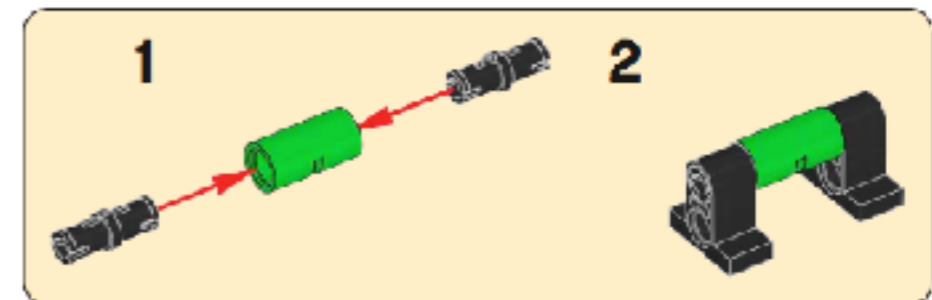

◆ 2 poutres perforées,
1x8 (vert citron)

21

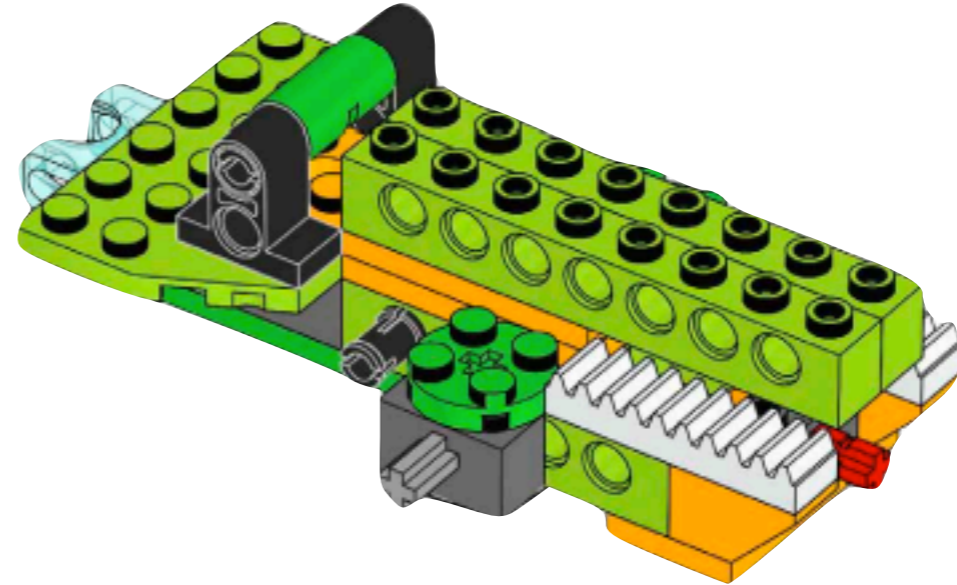
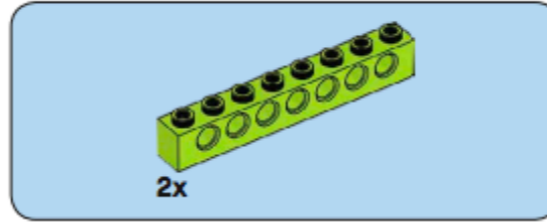

◆ 2 chevilles à friction,
2 modules (noir)

22

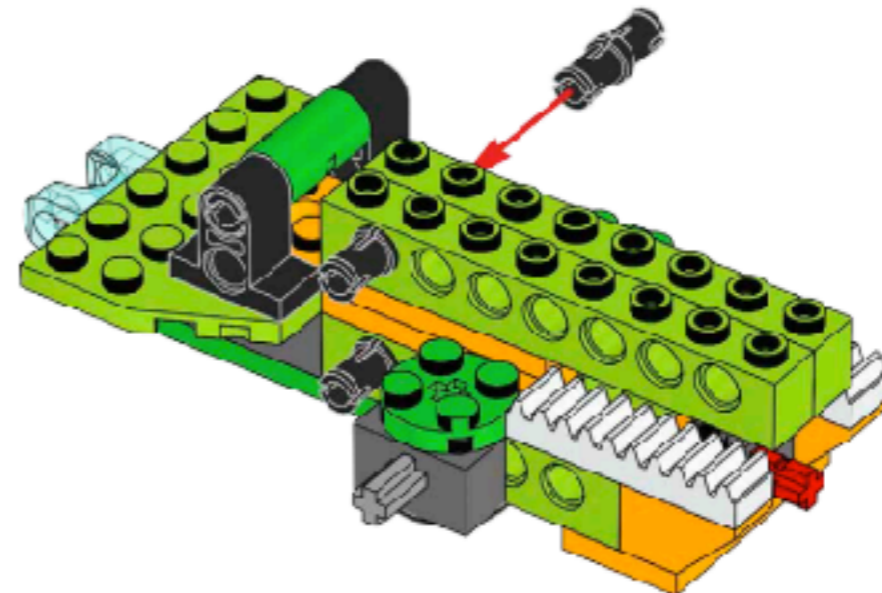

- ◆ 2 poutres coudées, 3x5 modules (vert vif)

23

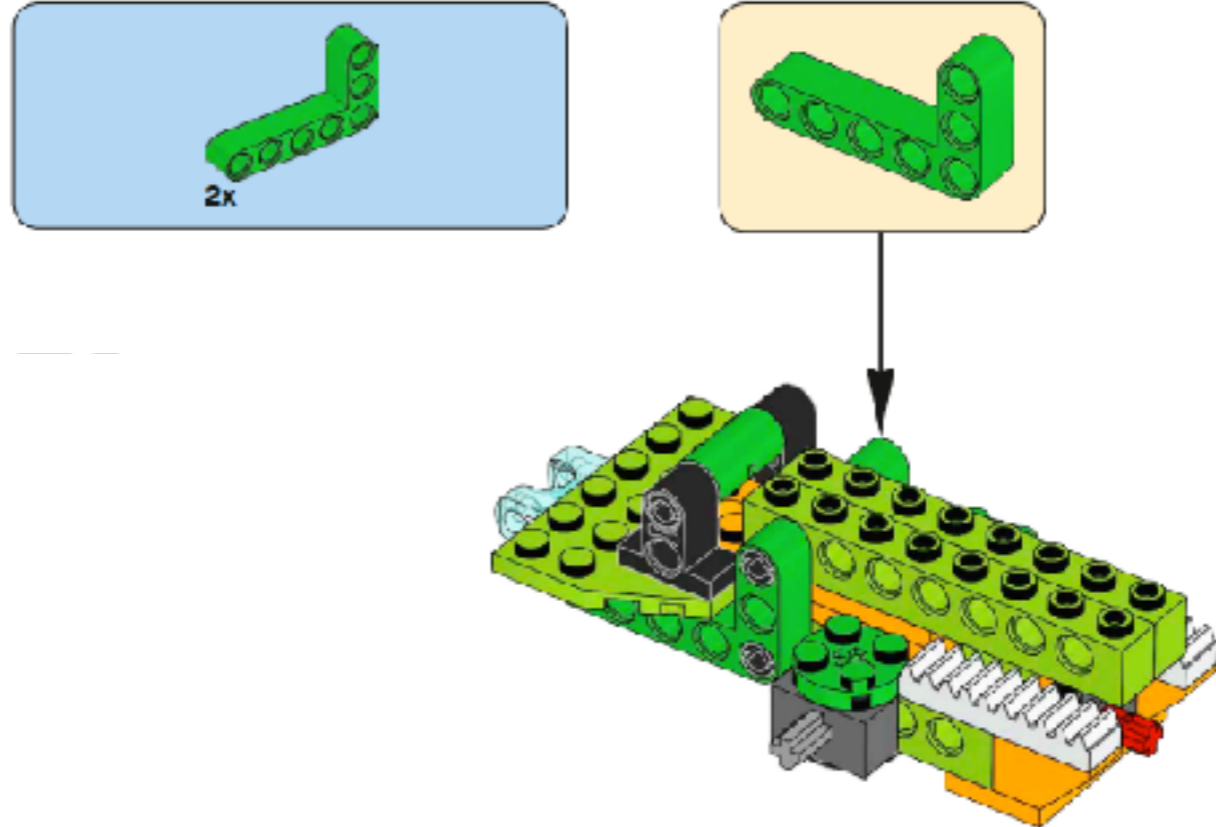

- ◆ 1 moteur moyen (blanc)
- ◆ 1 axe, 2 modules (rouge)

24

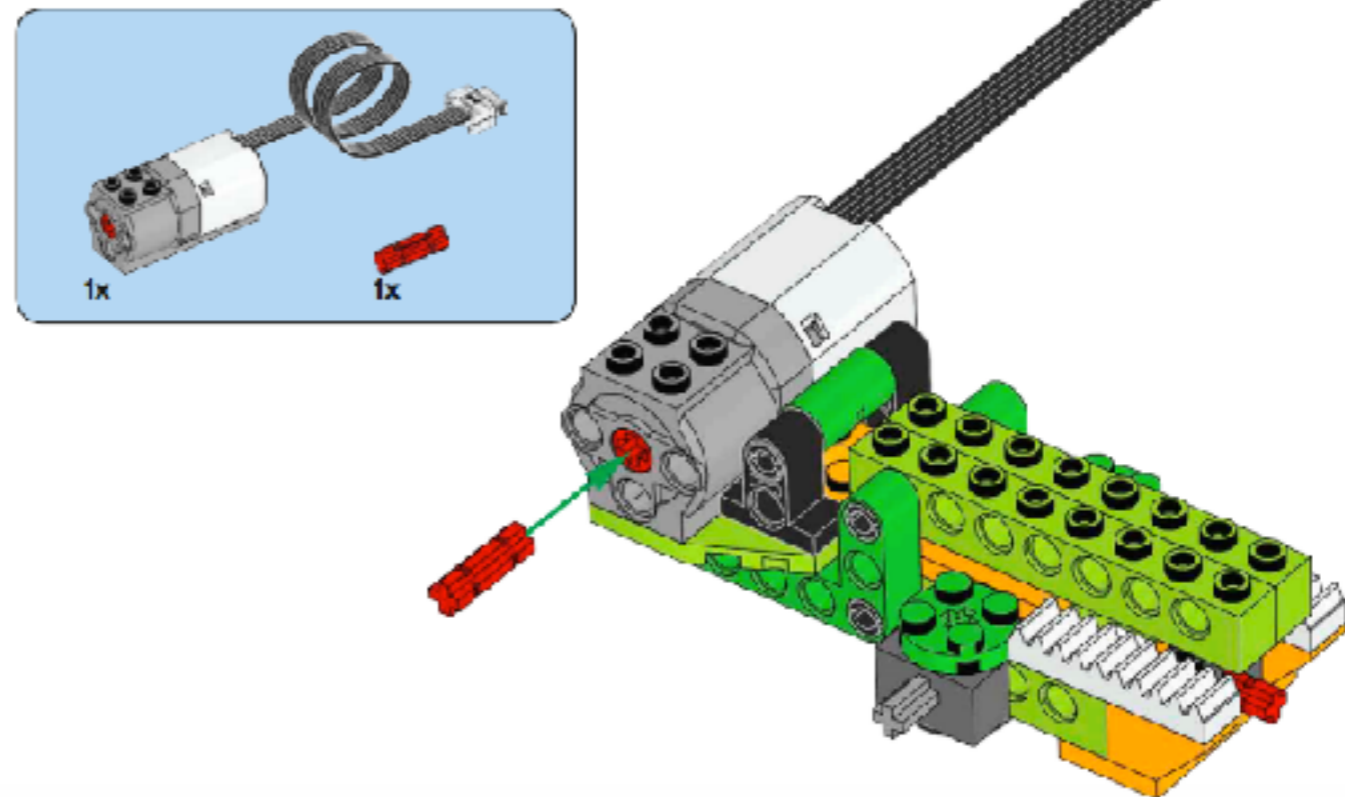

- ◆ 1 bague/poulie, 1/2 module (jaune)
- ◆ 1 moyeu/poulie, 24x4 mm (bleu clair transparent)

25

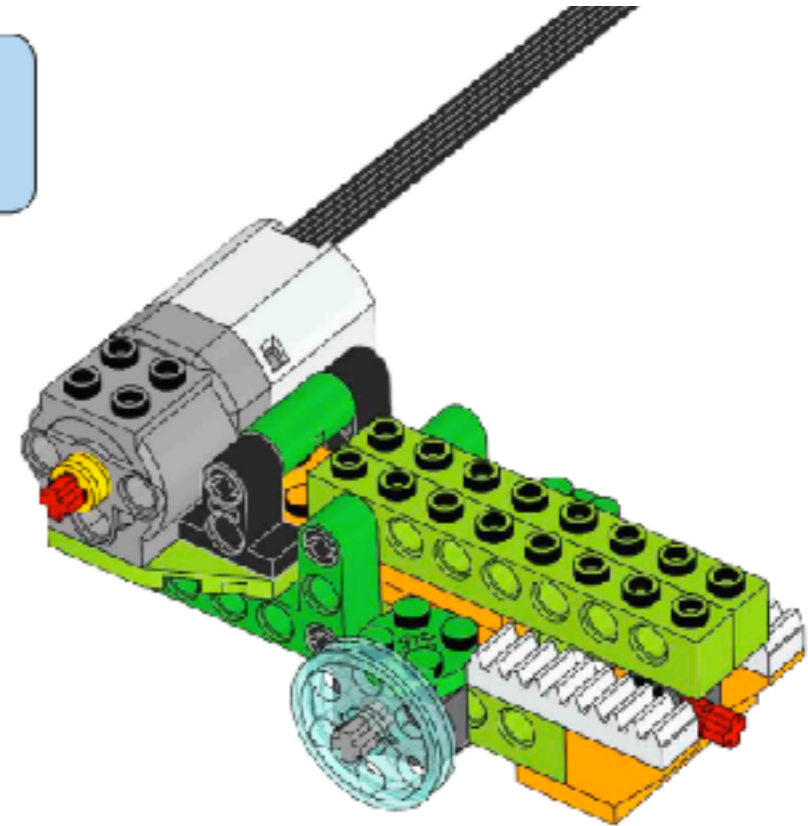
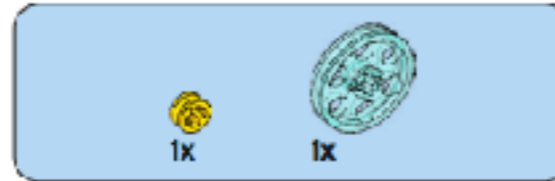

- ◆ 1 courroie, 33 mm (jaune)

26

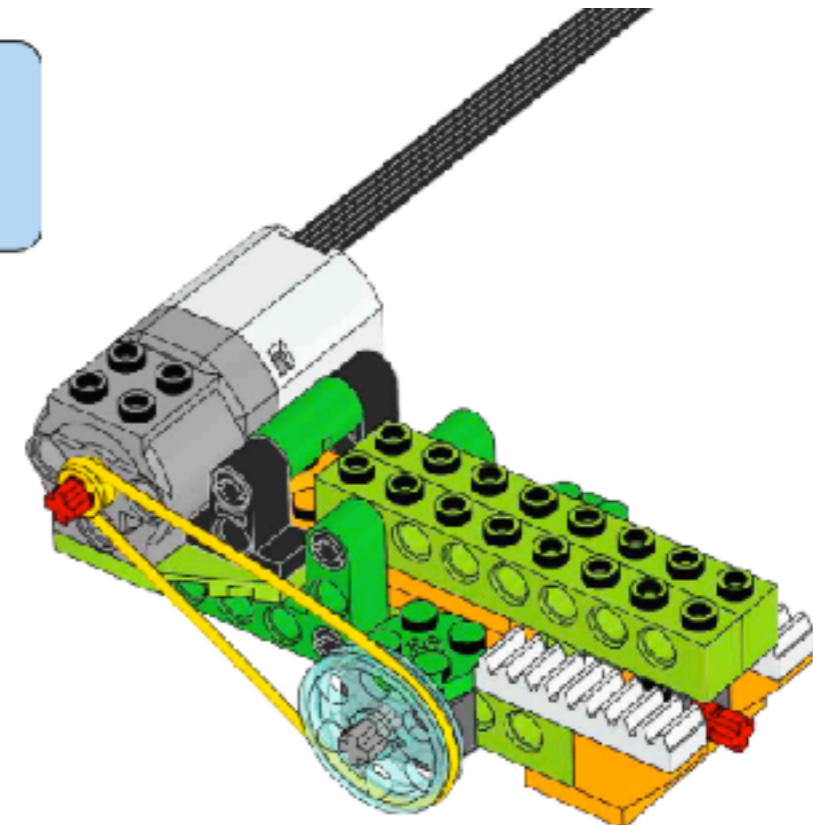
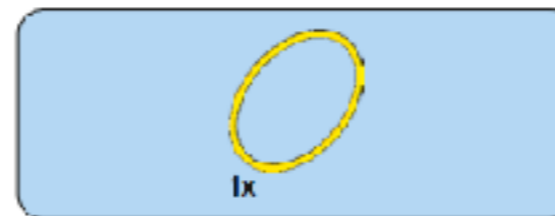

◆ 1 brique intelligente
(blanc)

27

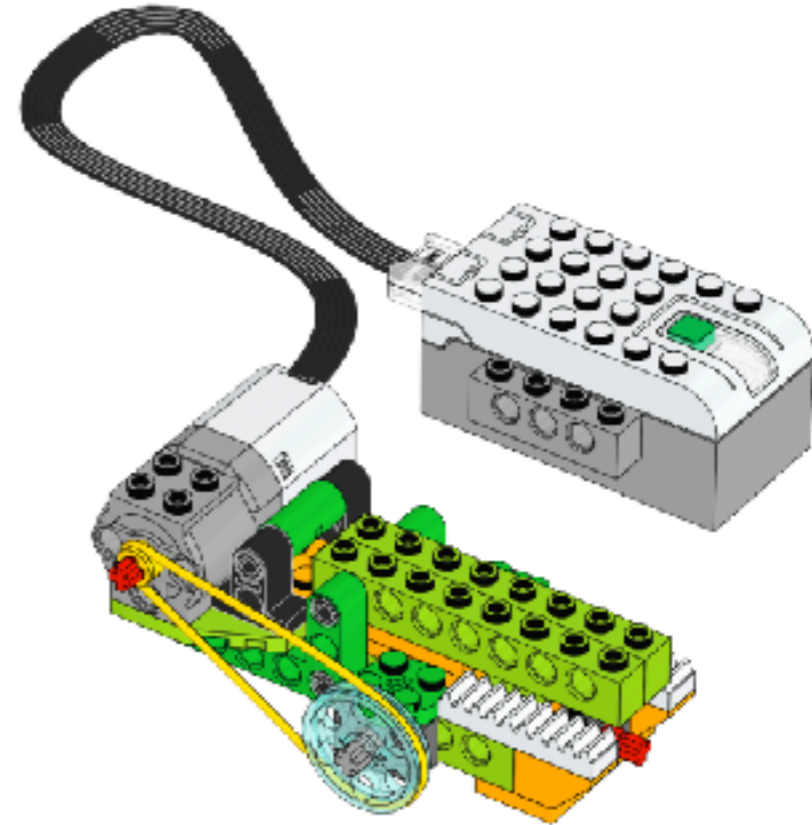
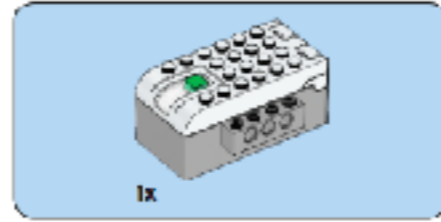

28

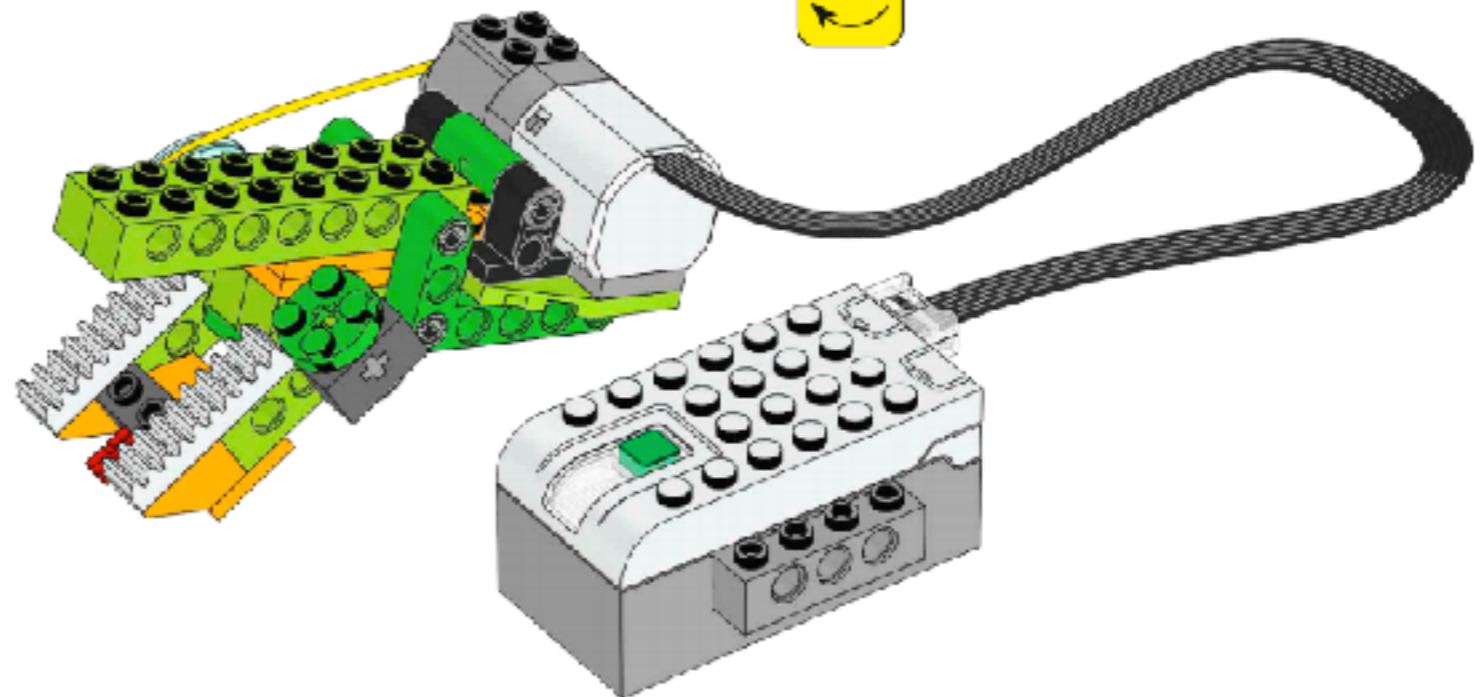

BRAVO!