

Levier

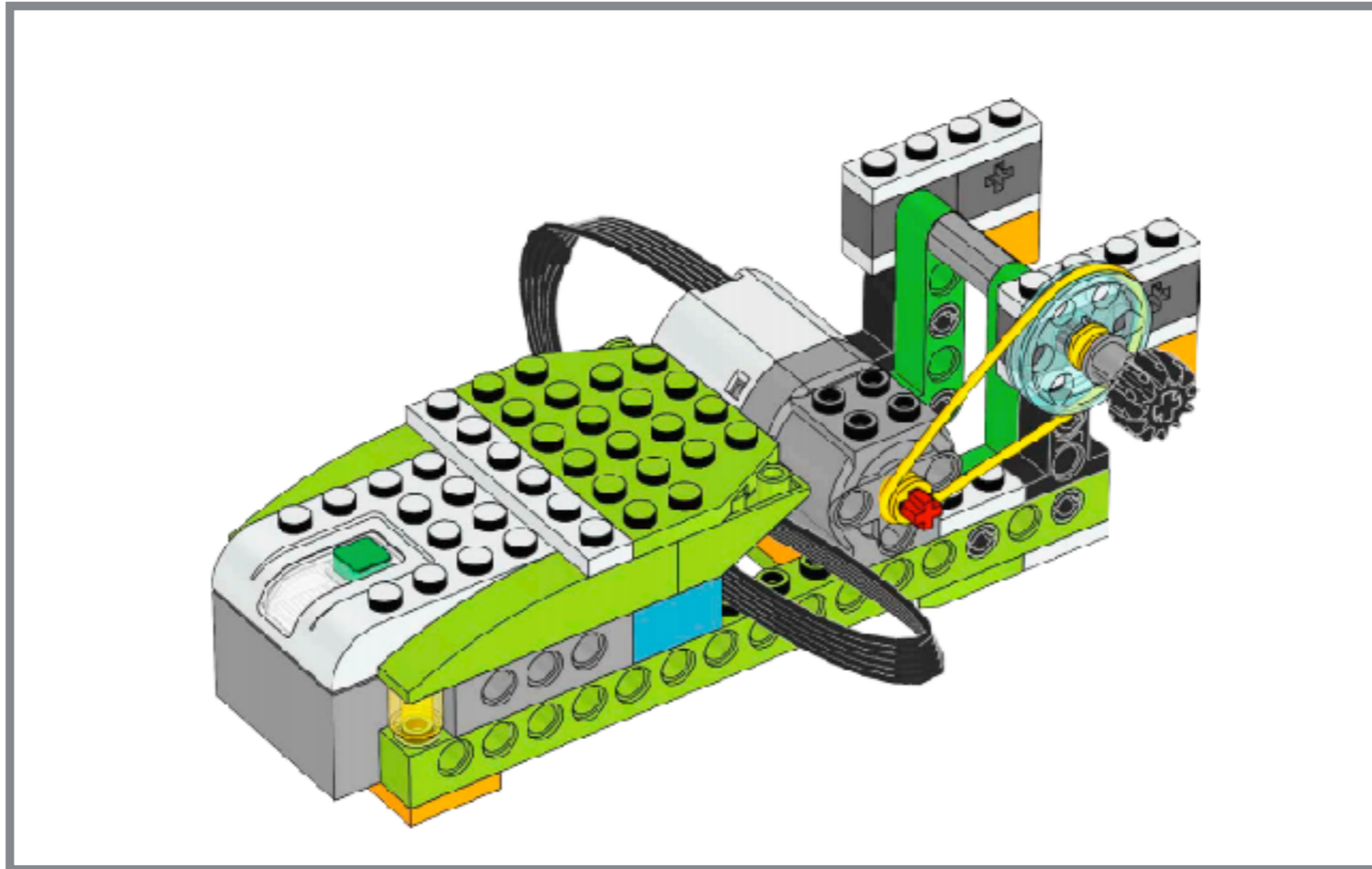

WeDo 2.0 de LEGO Education

Modification et bonification des plans par le Service national du RÉCIT à l'éducation préscolaire

Lynda O'Connell, conseillère pédagogique en TIC et Isabelle Therrien, enseignante à l'éducation préscolaire



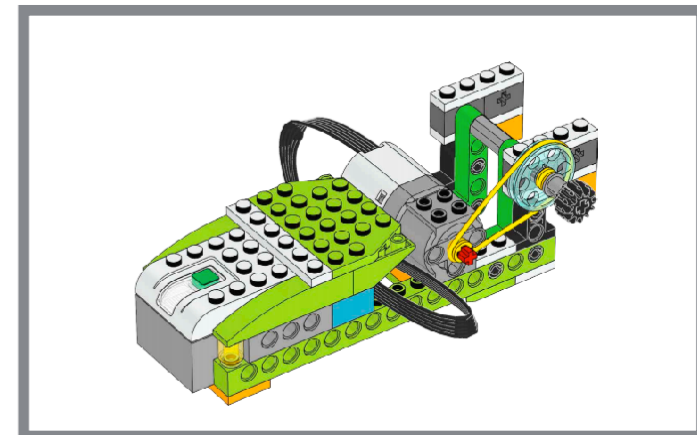

Nombre d'étapes : 32

Nom original du modèle : Lift

Remarque : Aucun capteur dans ce modèle

INVENTAIRE DES PIÈCES

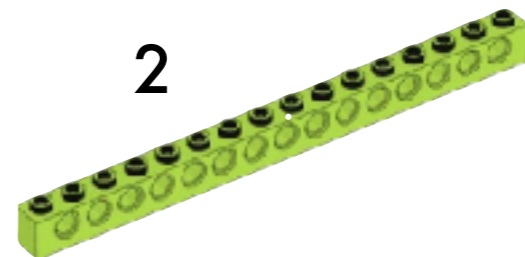
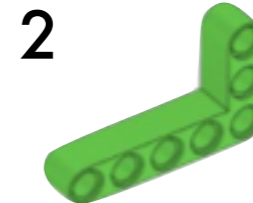
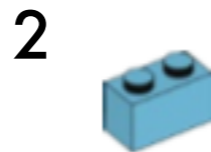
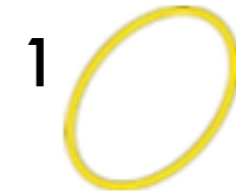
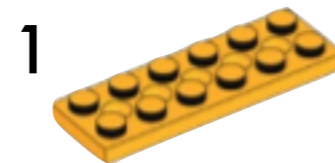
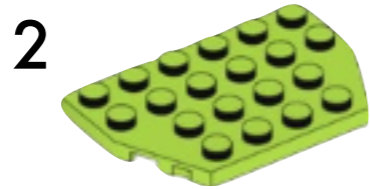
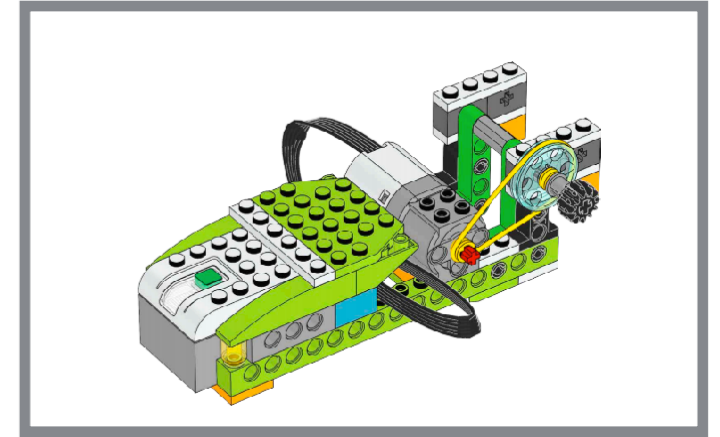
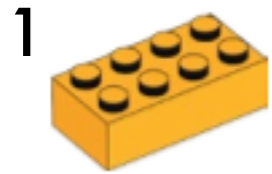

- ◆ 1 brique, 2x4 (orange vif)
- ◆ 1 plaque, 4x6/4 (vert citron)

1

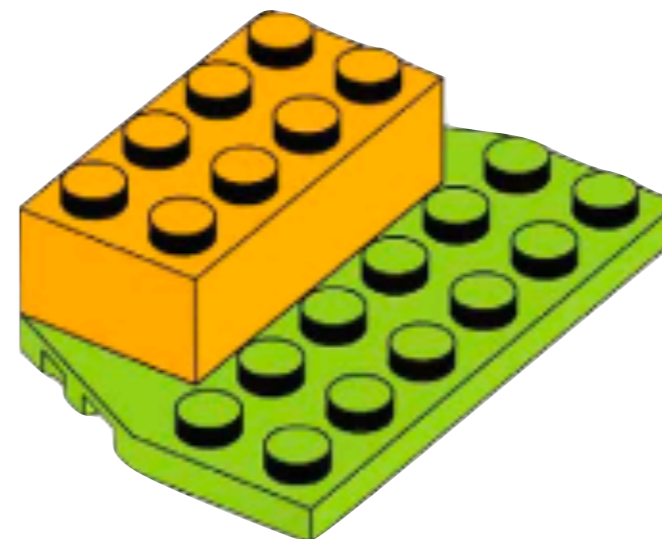
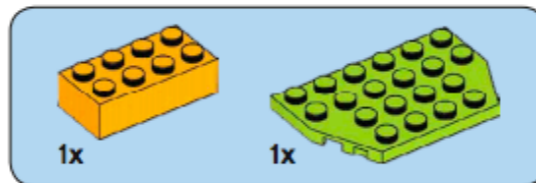

- ◆ 1 poutre perforée, 1x16 (vert citron)
- ◆ 1 plaque, 1x2 (blanc)
- ◆ 1 poutre avec plaque, 2 modules (noir)

2

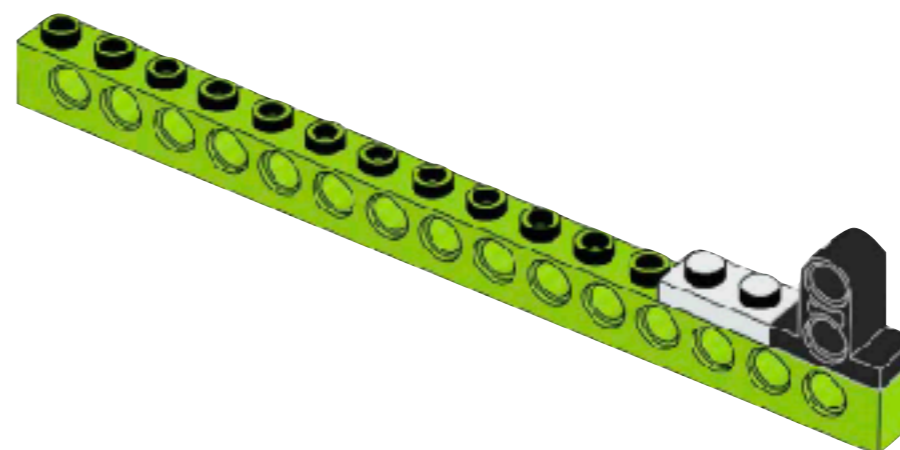
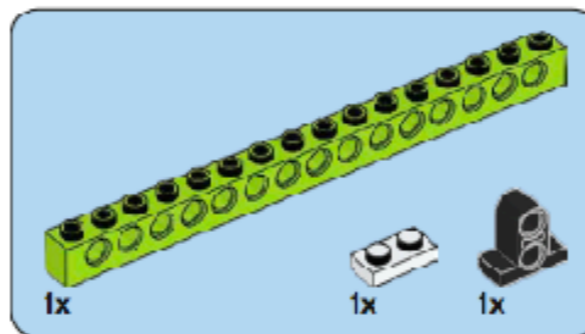

- ◆ 1 plaque, 1x2 (blanc)
- ◆ 3 chevilles à friction, 2 modules (noir)

3

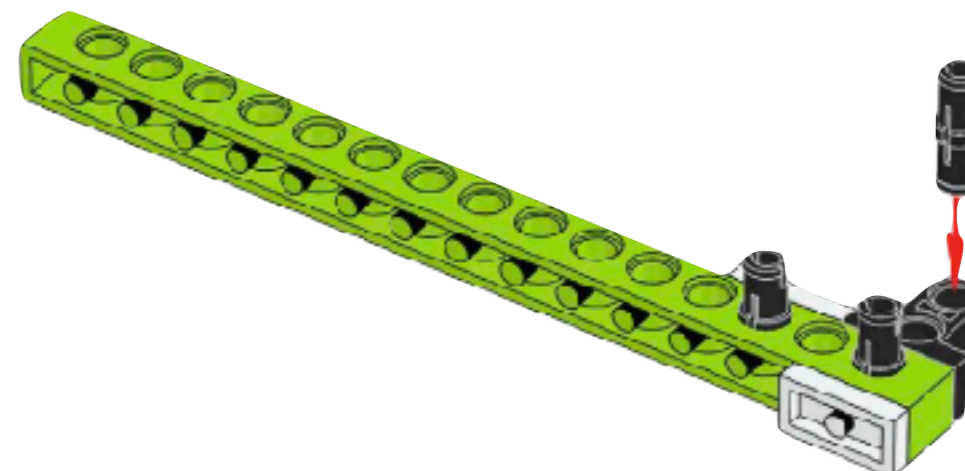

- ◆ 1 poutre coudée, 3x5 modules (vert vif)

4

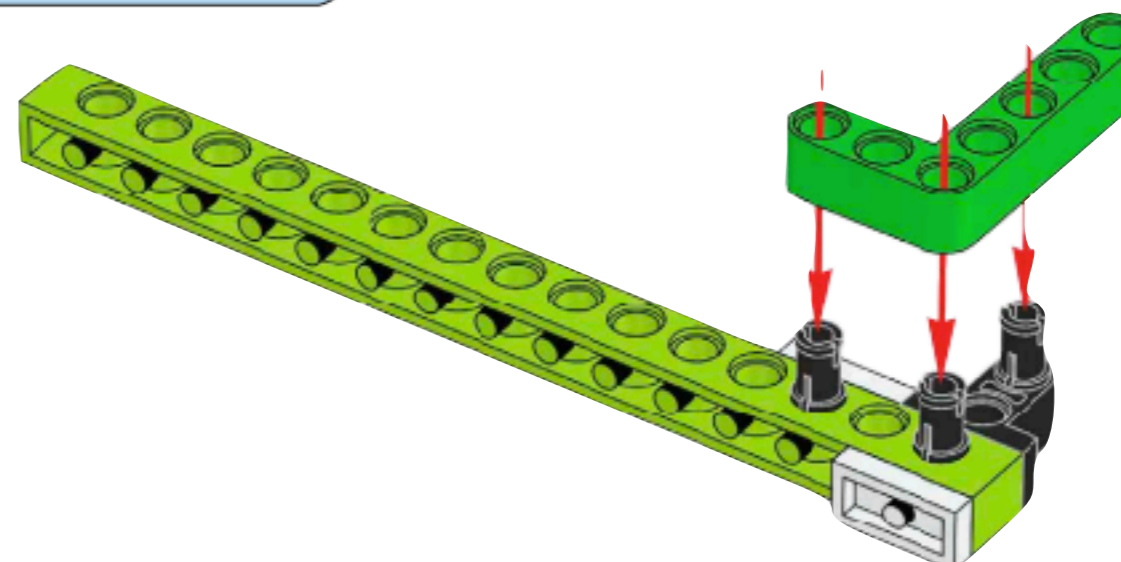
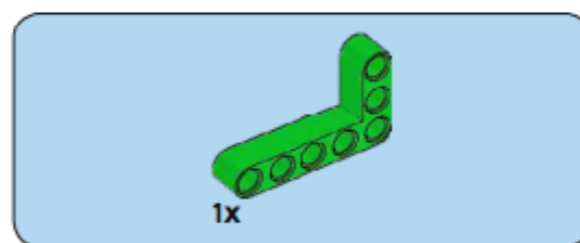

5

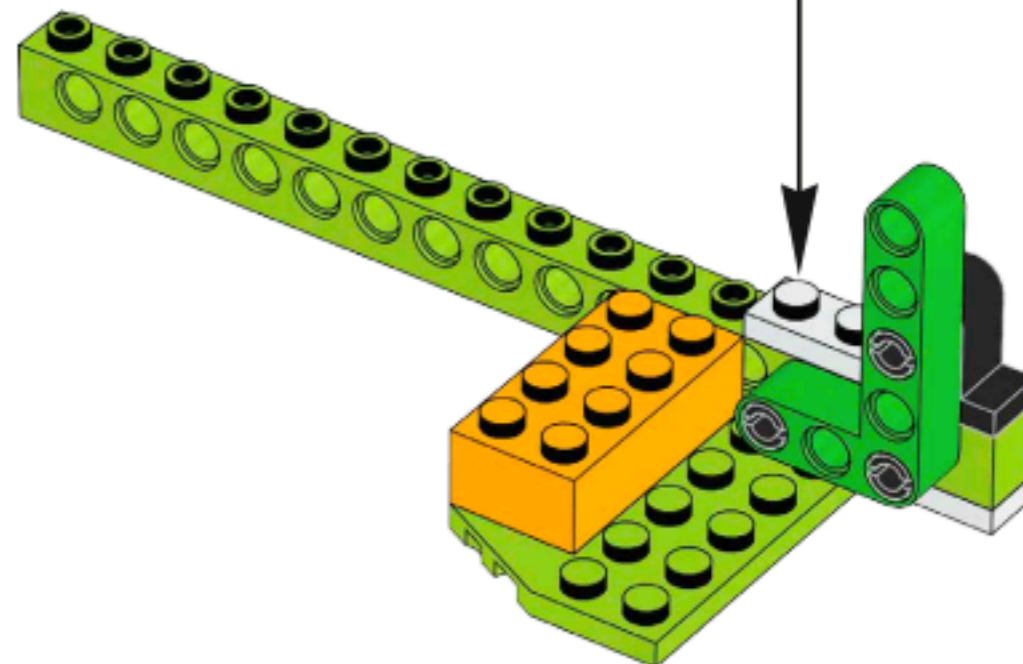

- ◆ 1 poutre perforée, 1x16 (vert citron)
- ◆ 1 plaque, 1x2 (blanc)
- ◆ 1 poutre avec plaque, 2 modules (noir)

6

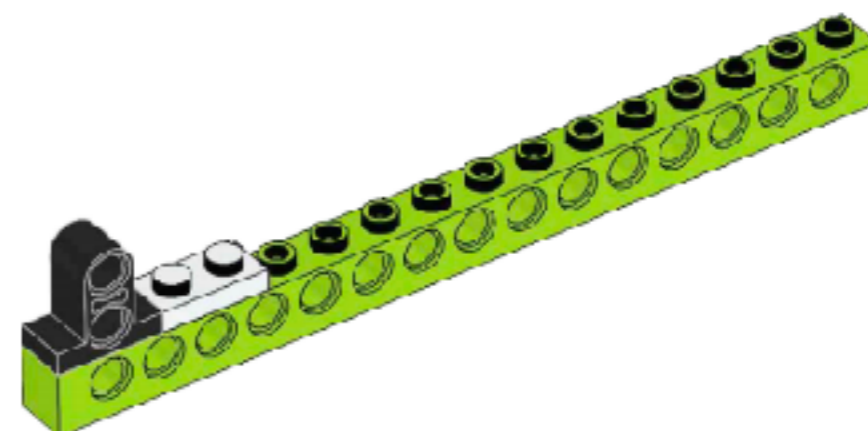
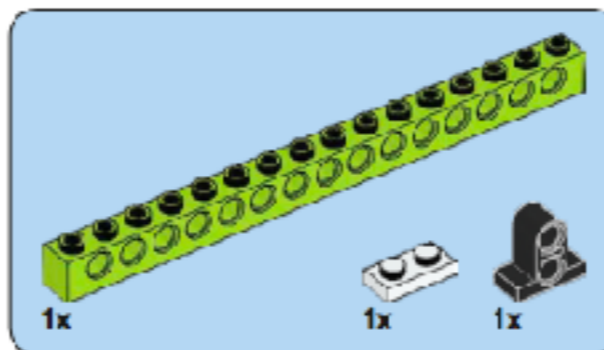

◆ 1 plaque, 1x2 (blanc)

◆ 3 chevilles à friction, 2 modules (noir)

7

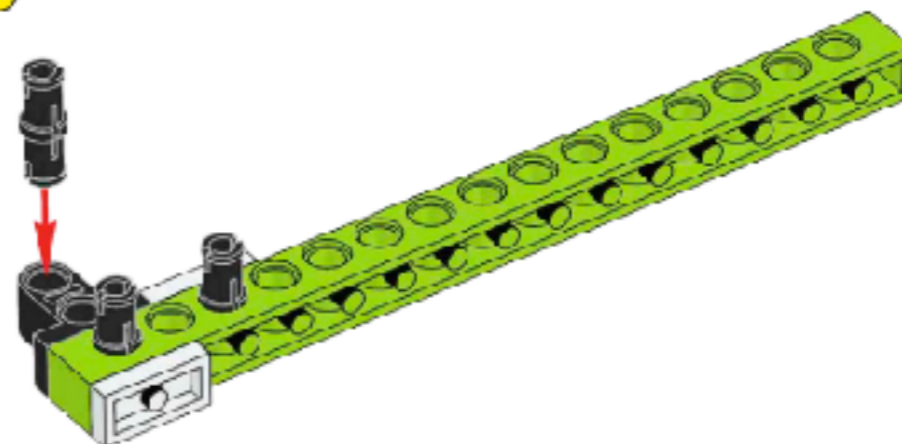

◆ 1 poutre coudée, 3x5 modules (vert vif)

8

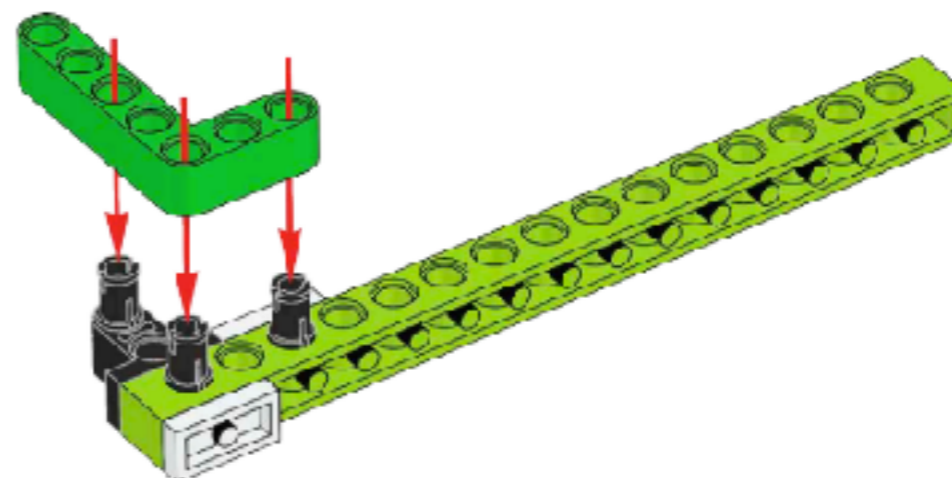
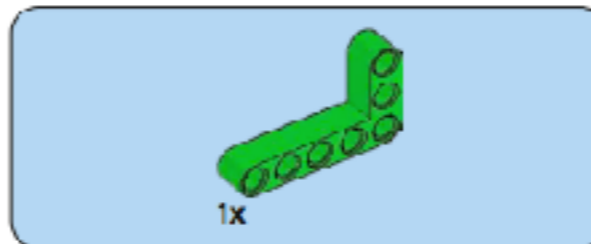

9

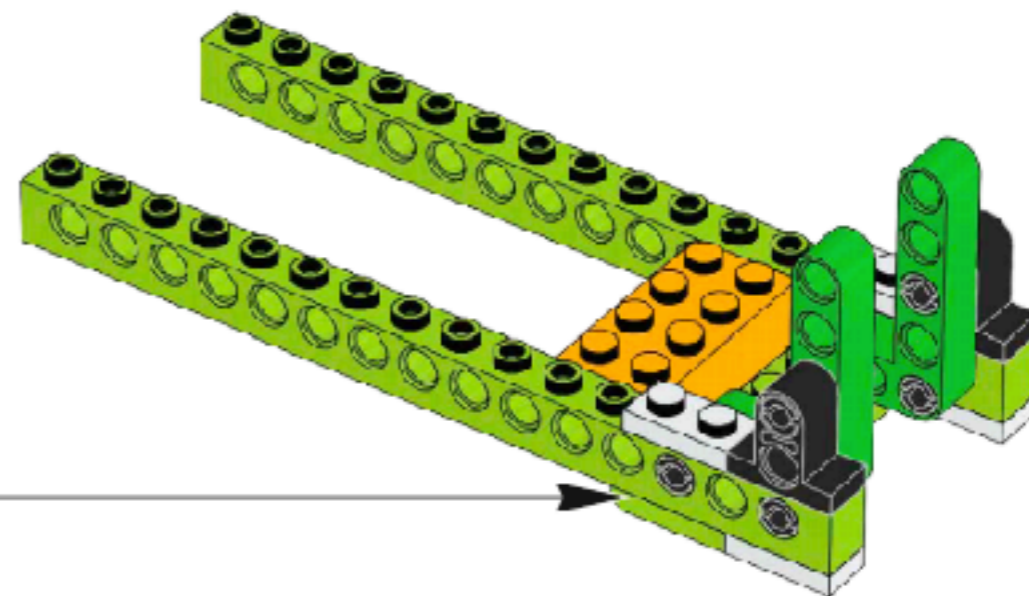

◆ 1 plaque percée, 2x6
(orange vif)

10

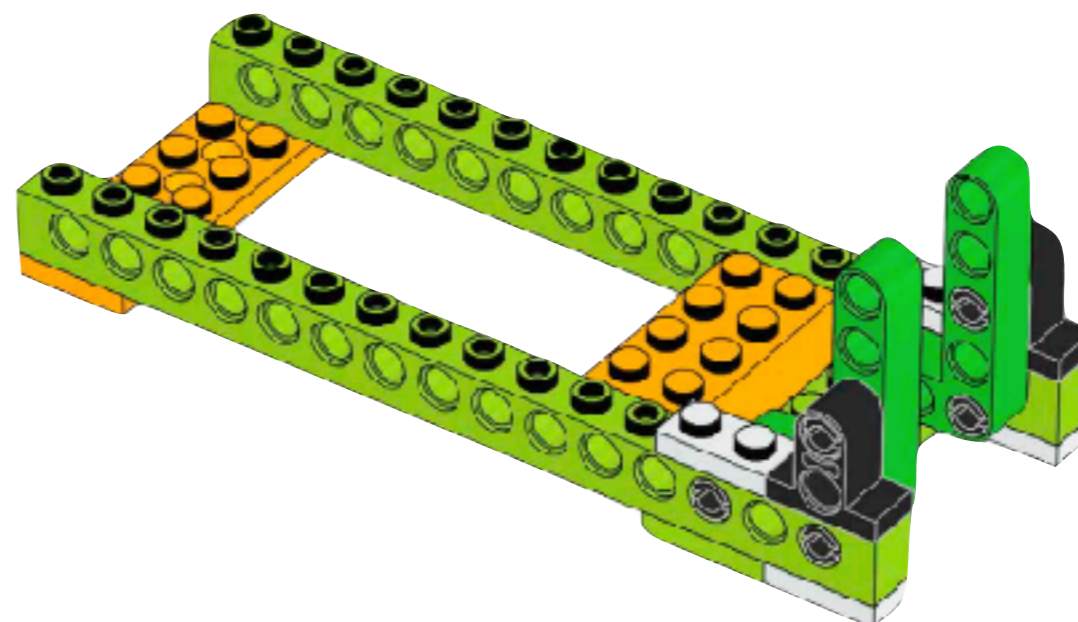
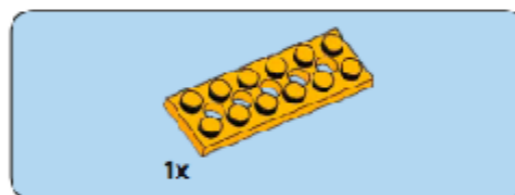

◆ 1 axe, 3 modules (gris)

11

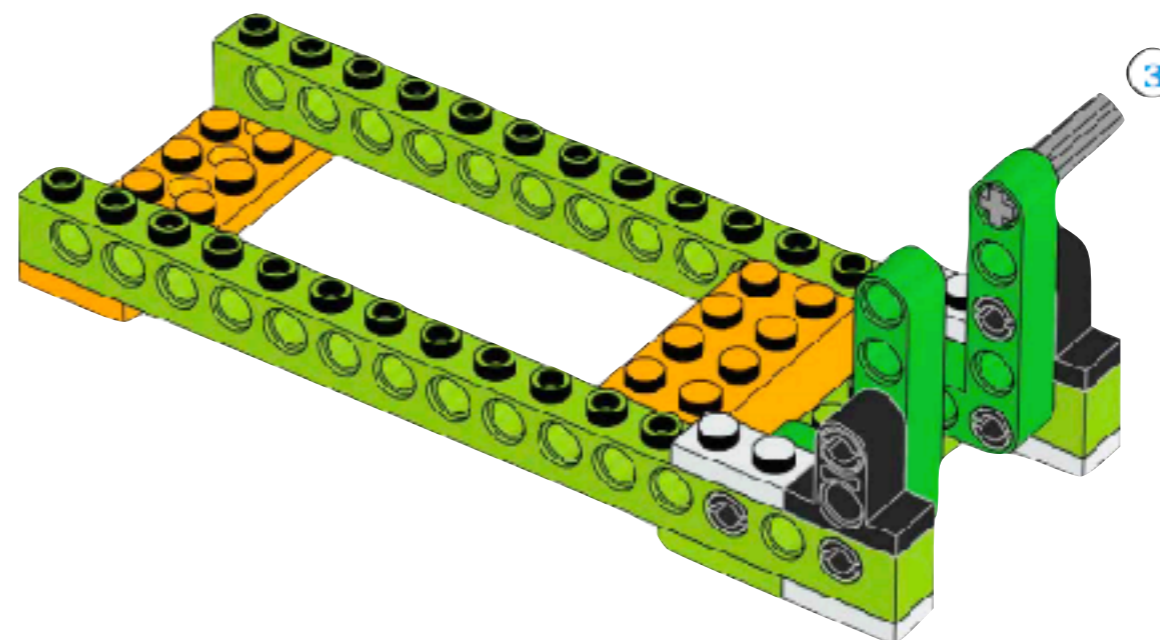
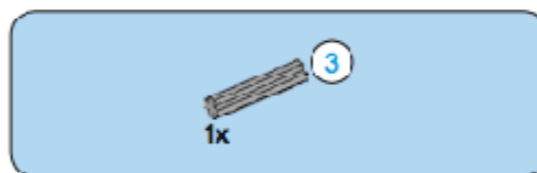

◆ 1 bague/allonge d'axe, 2 modules (gris)

12

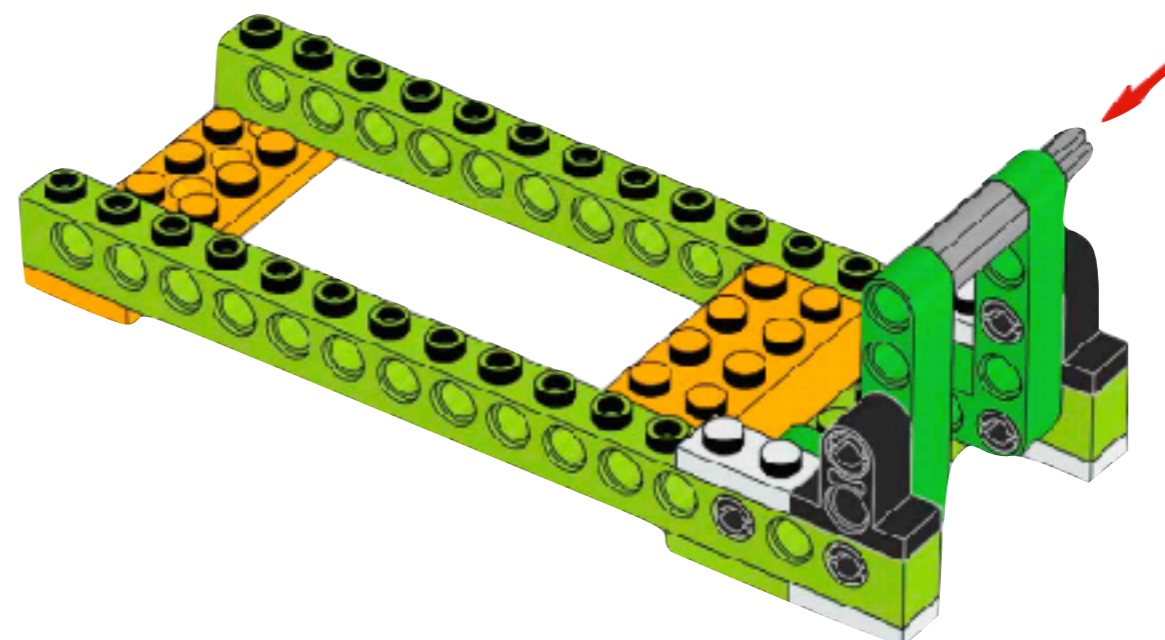

◆ 1 axe, 6 modules (noir)

13

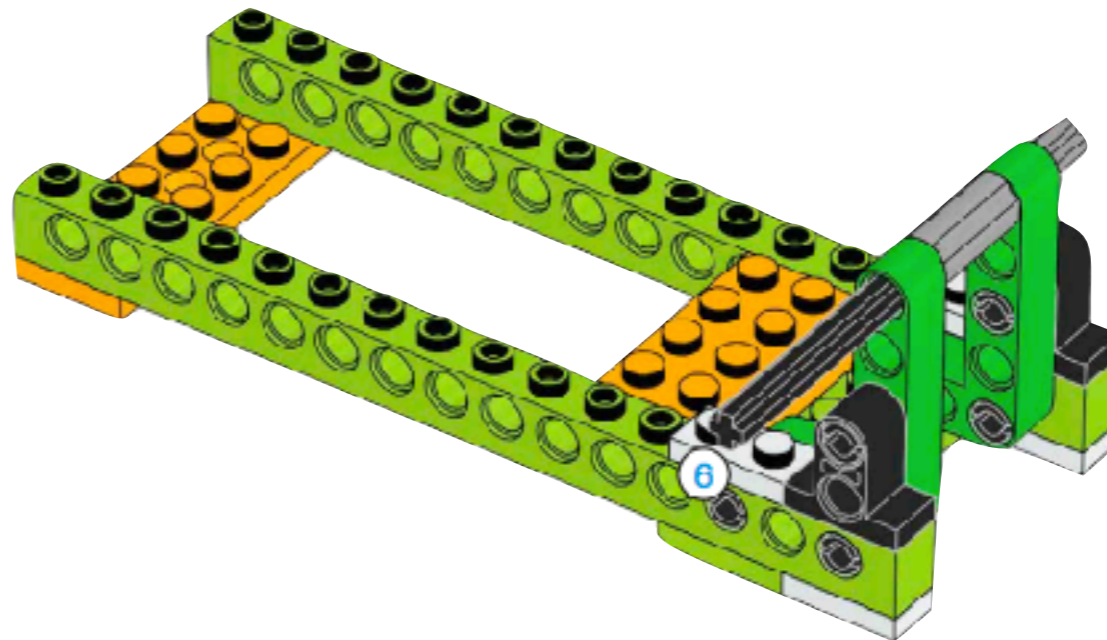
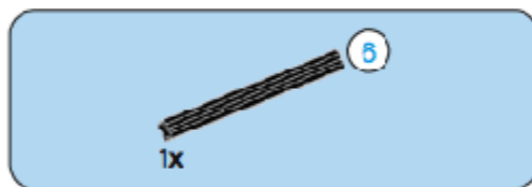

◆ 2 briques rondes, 1x1
(jaune transparent)

14

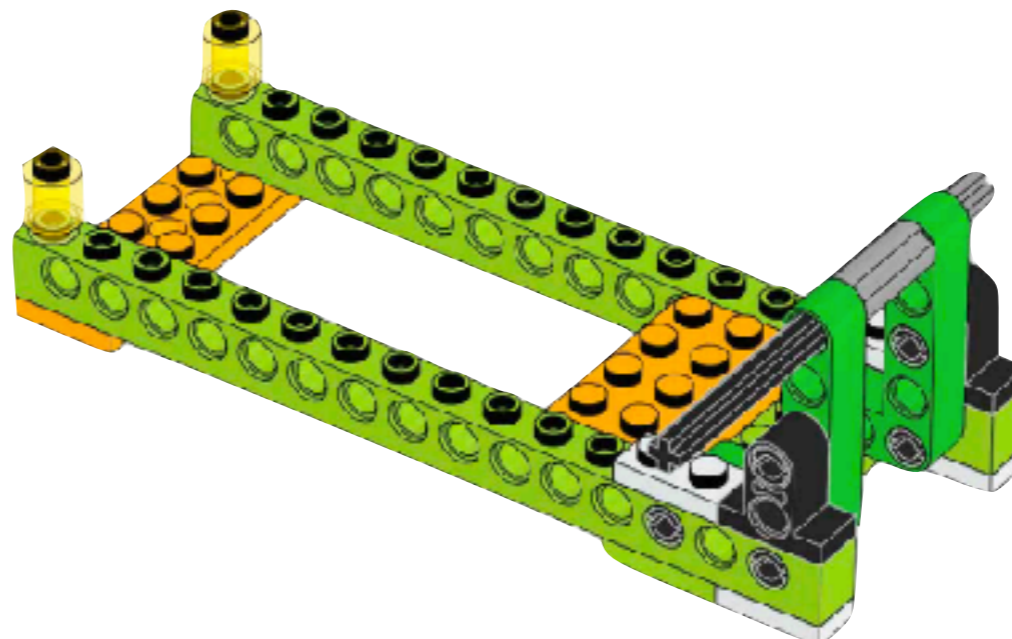

◆ 1 brique intelligente
(blanc)

15

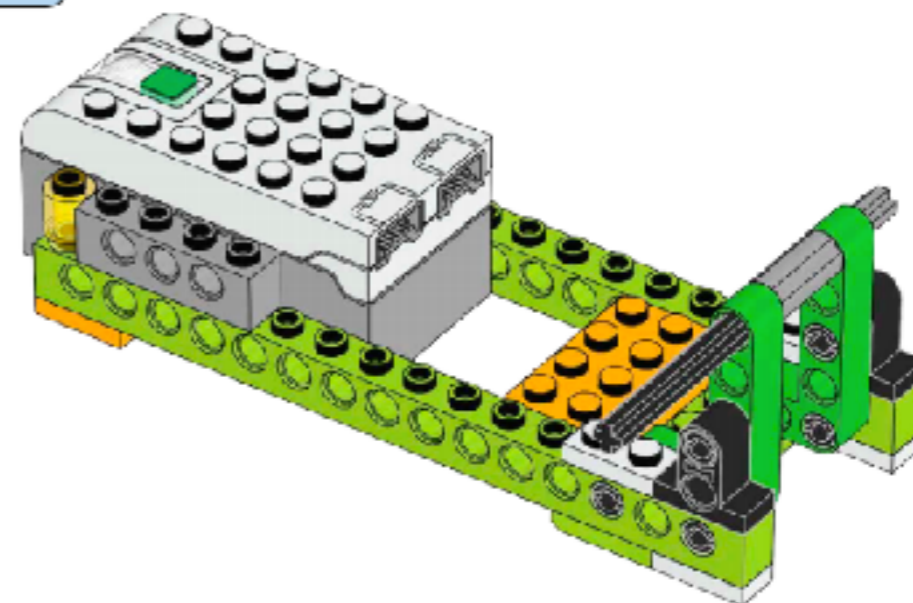
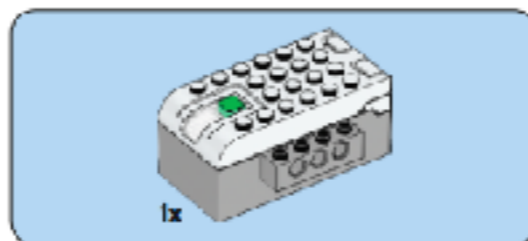

◆ 2 briques, 1x2 (bleu
azur)

16

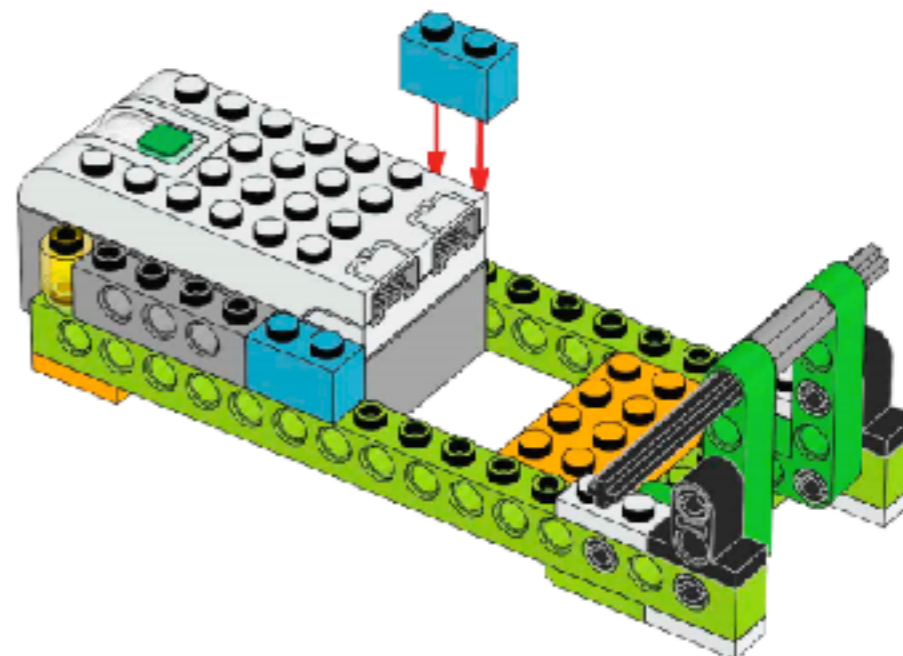
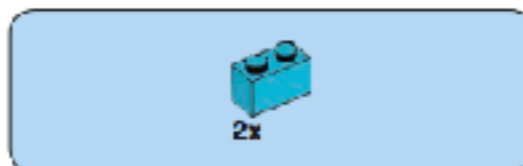

◆ 2 briques incurvées,
1x6 (vert citron)

17

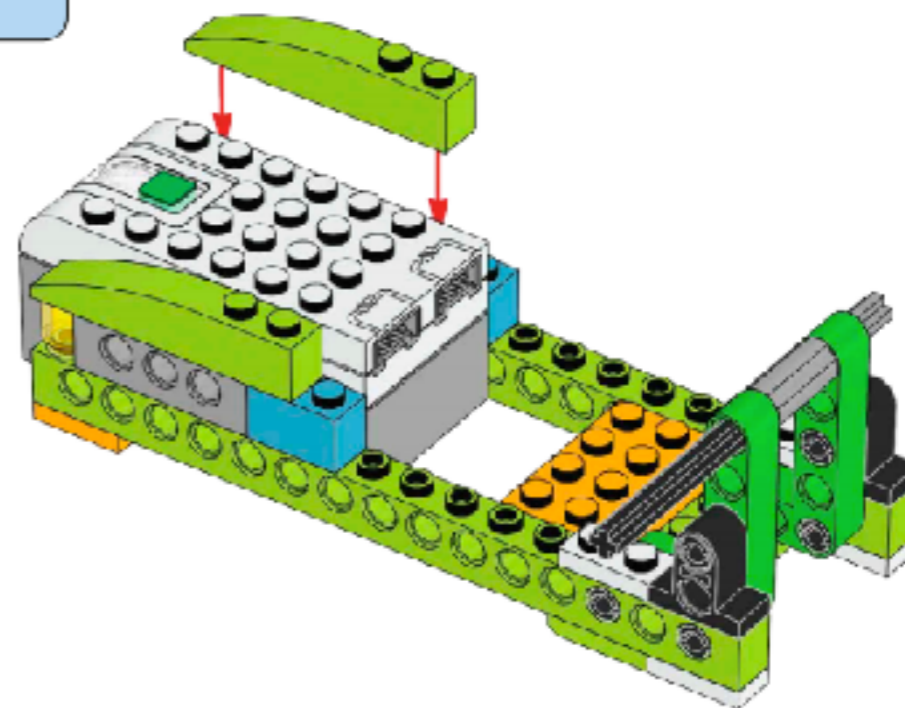
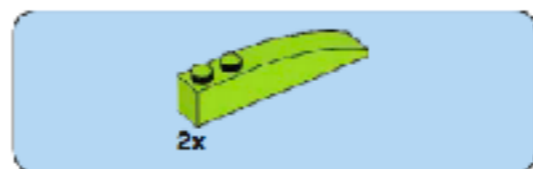

◆ 1 moteur moyen (blanc)

18

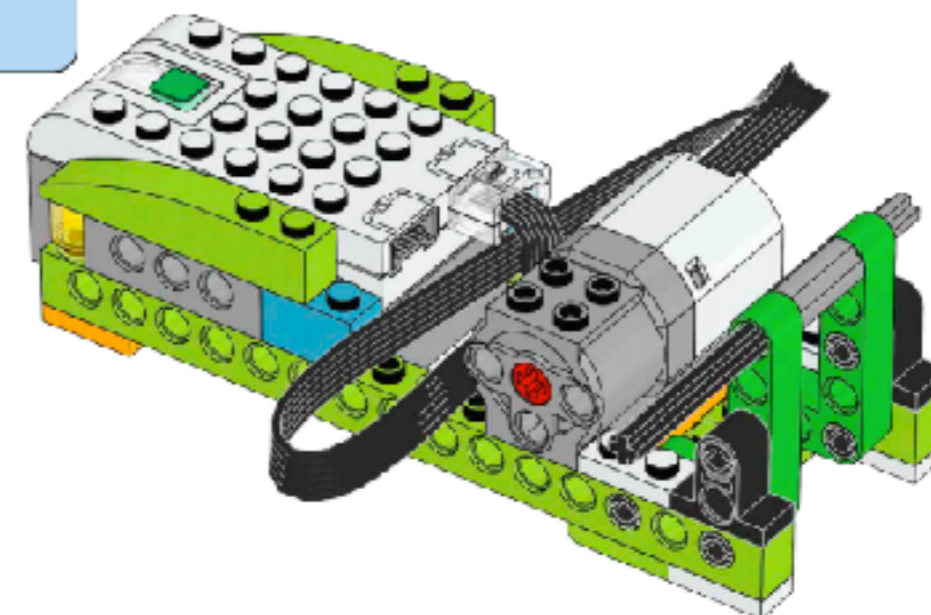
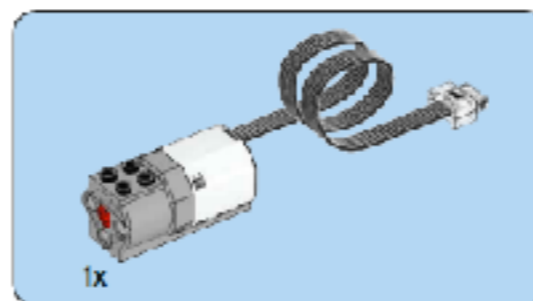

- ◆ 2 briques inclinées inversées, 1x3/25° (vert citron)

19

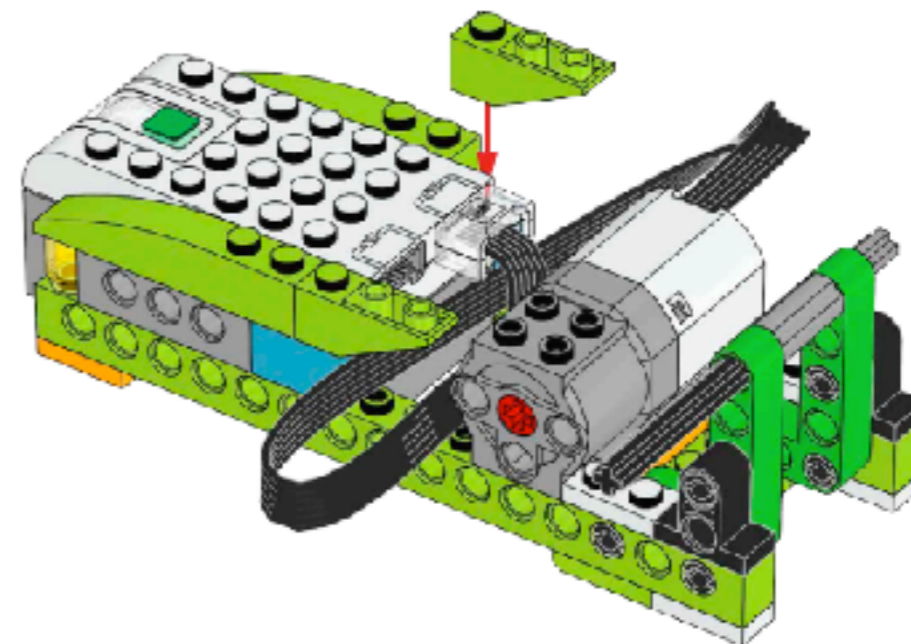

- ◆ 1 plaque, 1x6 (blanc)
- ◆ 1 plaque, 4x6/4 (vert citron)

20

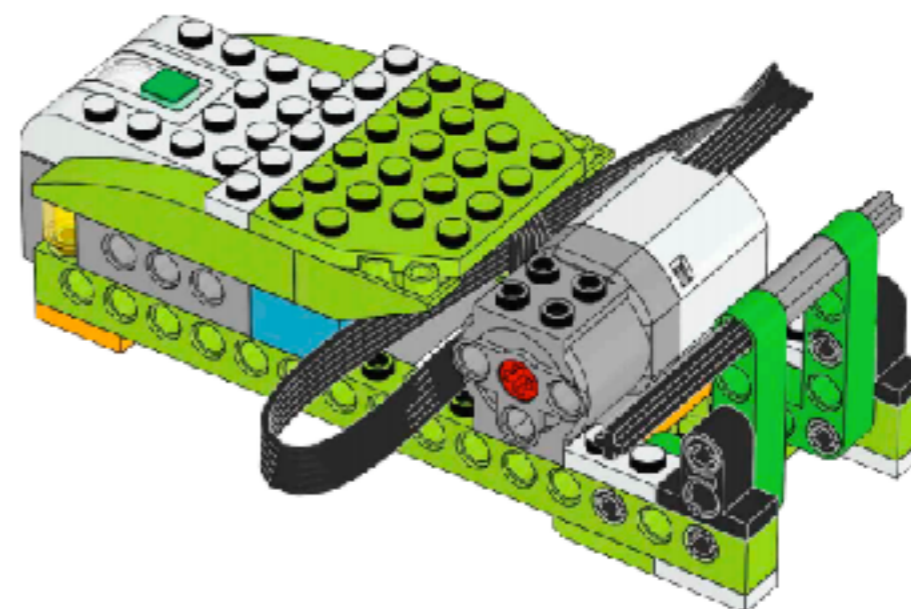
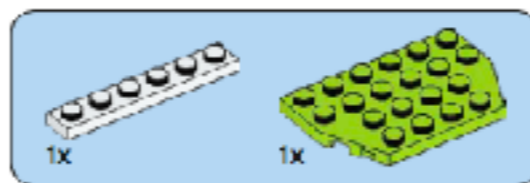

◆ 1 axe, 2 modules
(rouge)

21

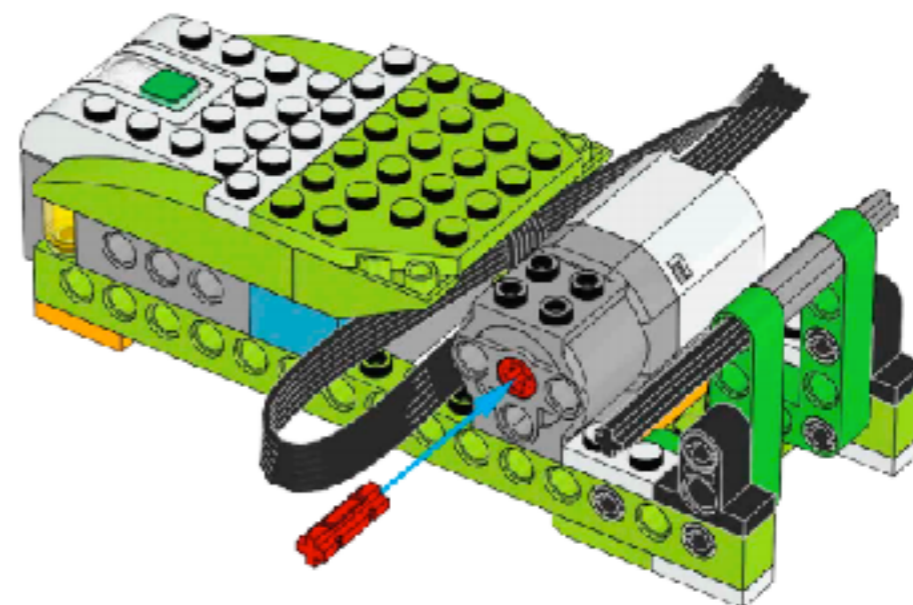

◆ 1 bague/poulie, 1/2
module (jaune)

22

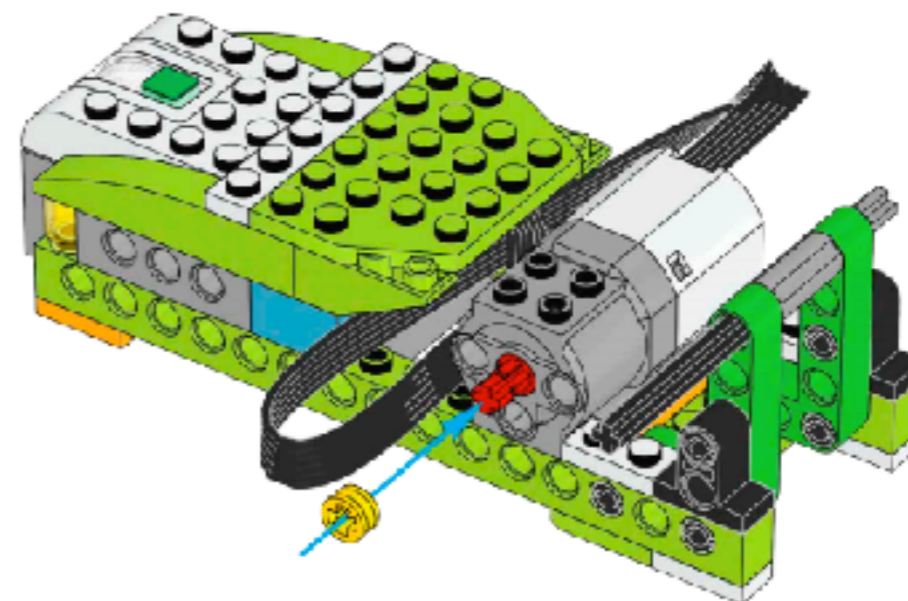
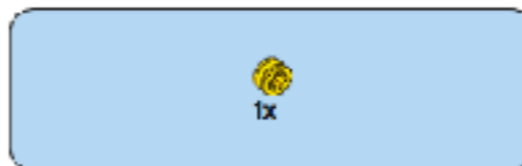

- ◆ 1 plaque, 1x4 (blanc)
- ◆ 1 poutre perforée avec trou en croix, 1x2 (gris)

23

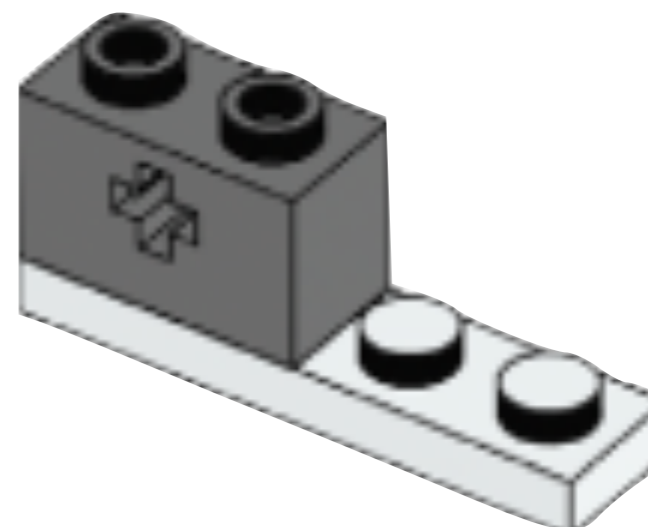
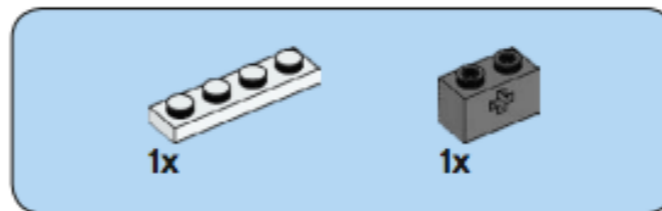

- ◆ 1 poutre perforée avec trou en croix, 1x2 (gris)

24

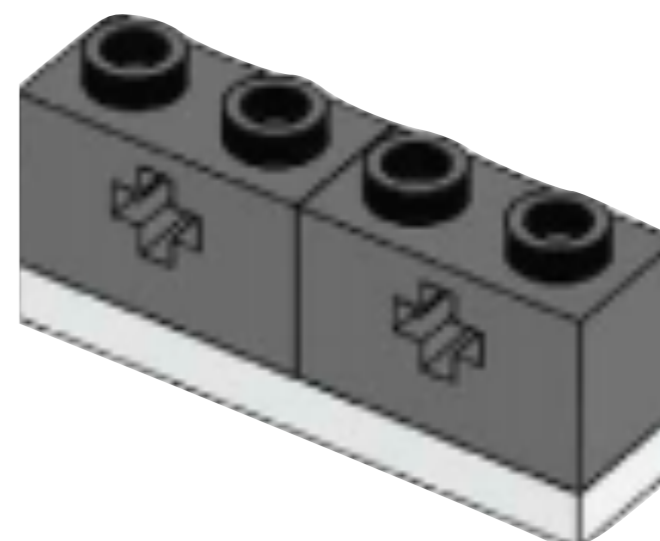
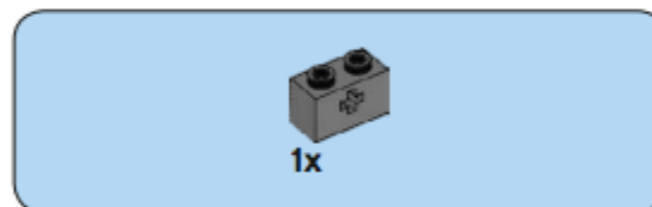

◆ 1 plaque, 1x4 (blanc)

25

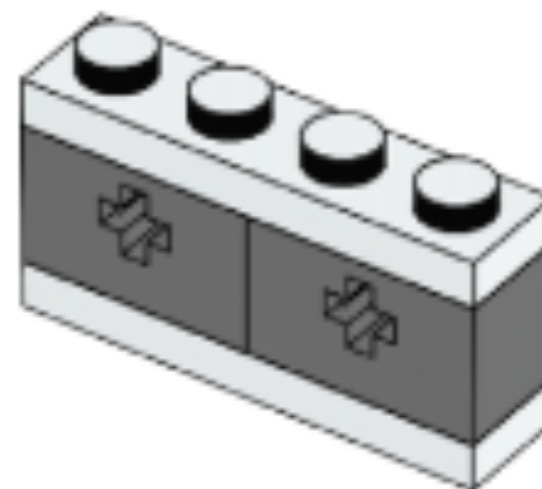
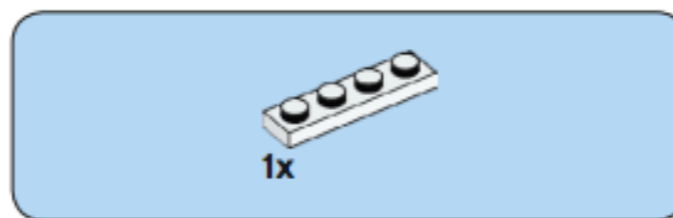

◆ 1 brique inclinée
inversée, 1x2/45°
(orange vif)

26

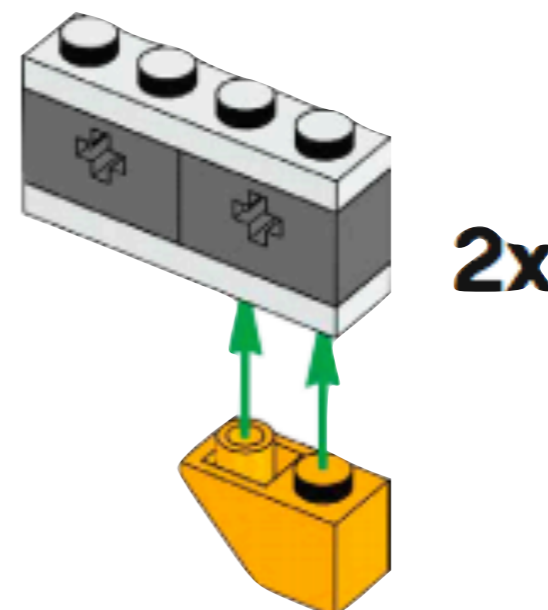

27

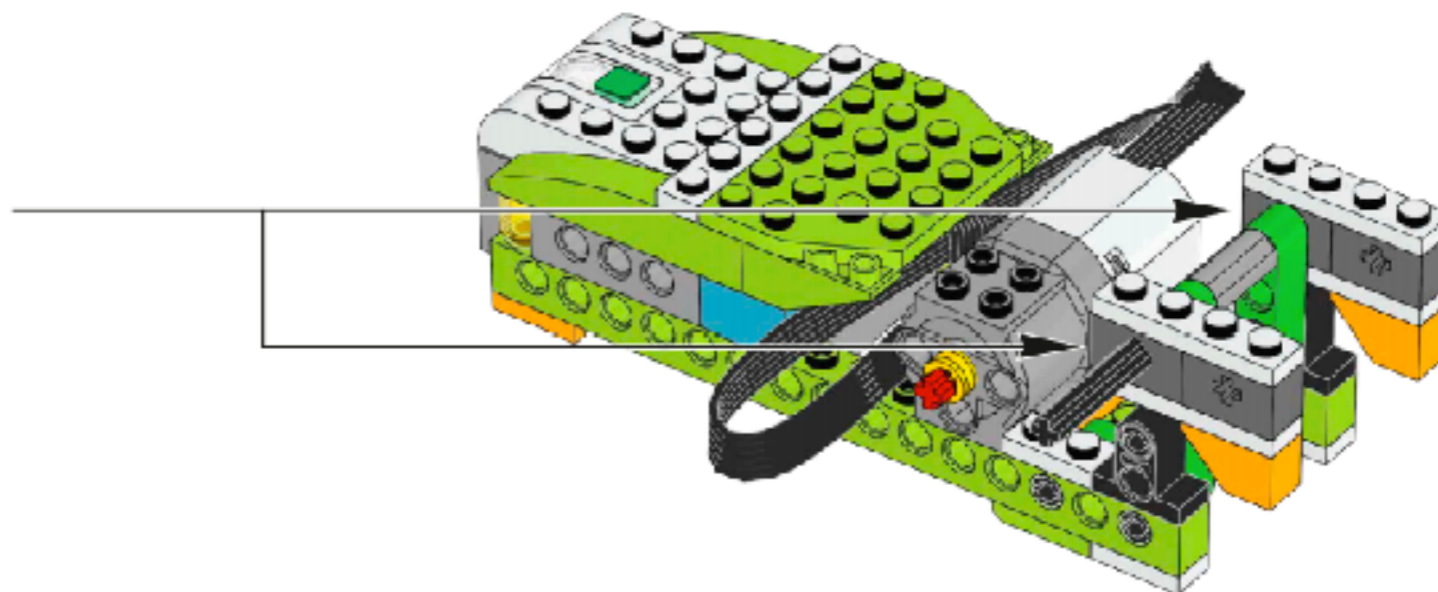

- ◆ 1 bague/poulie, 1/2 module (jaune)
- ◆ 1 moyeu/poulie, 24x4 mm (bleu clair transparent)

28

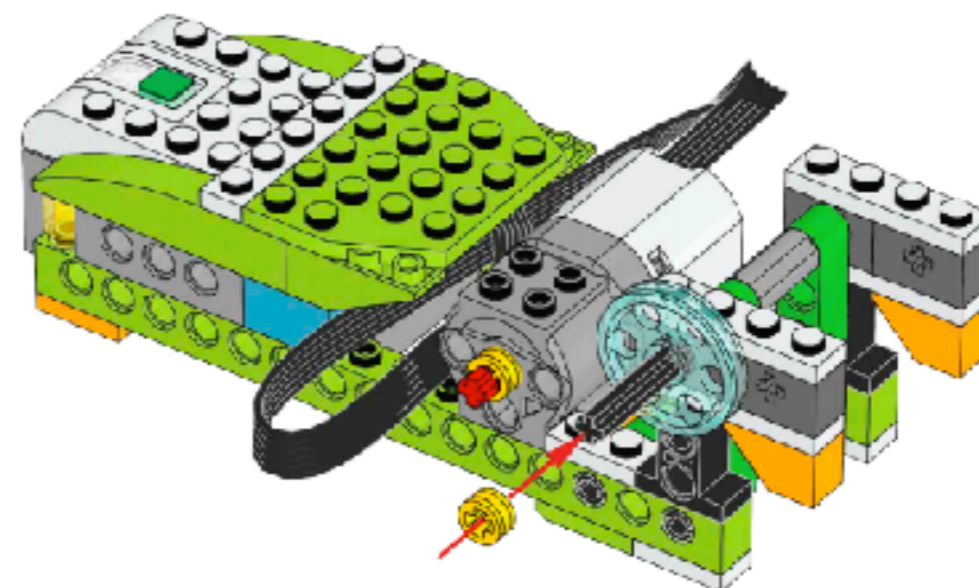
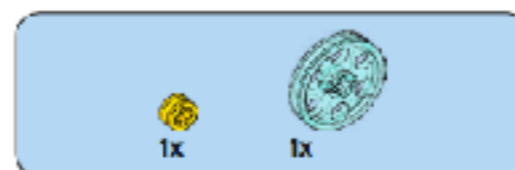

◆ 1 bague, 1 module
(gris)

29

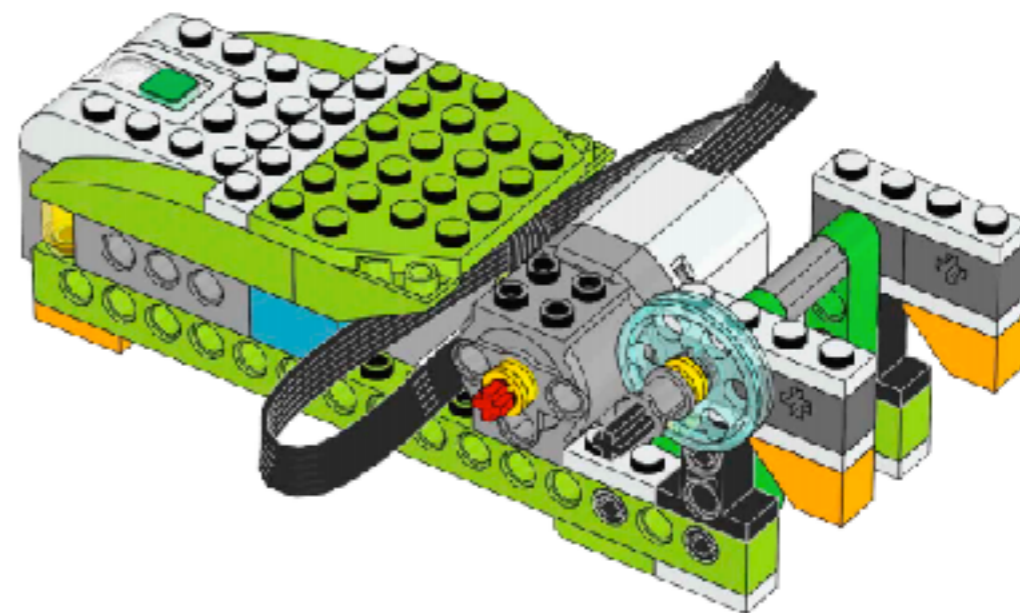

◆ 1 engrenage, 8 dents
(gris foncé)

30

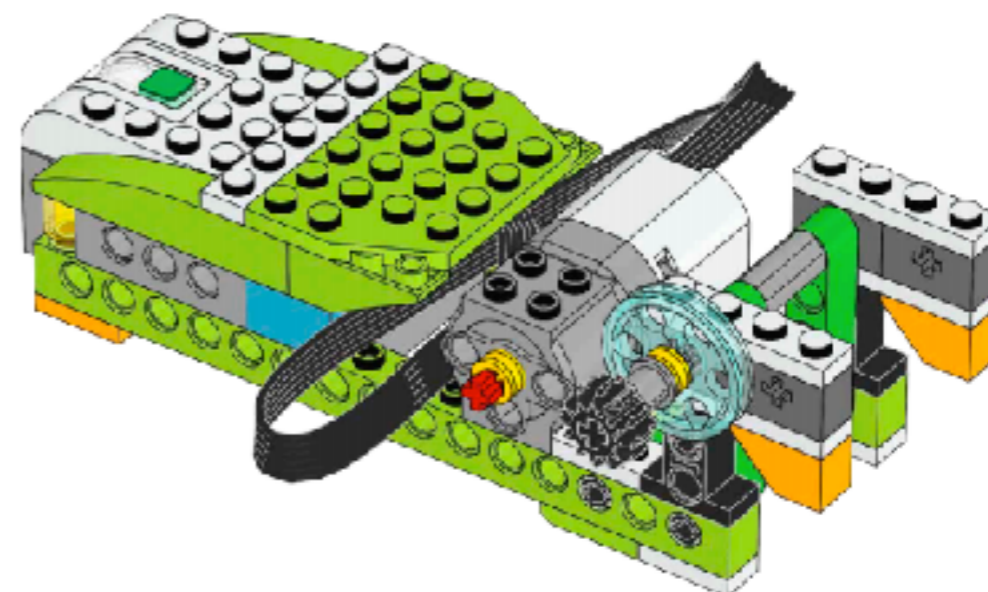

◆ 1 courroie, 33 mm
(jaune)

31

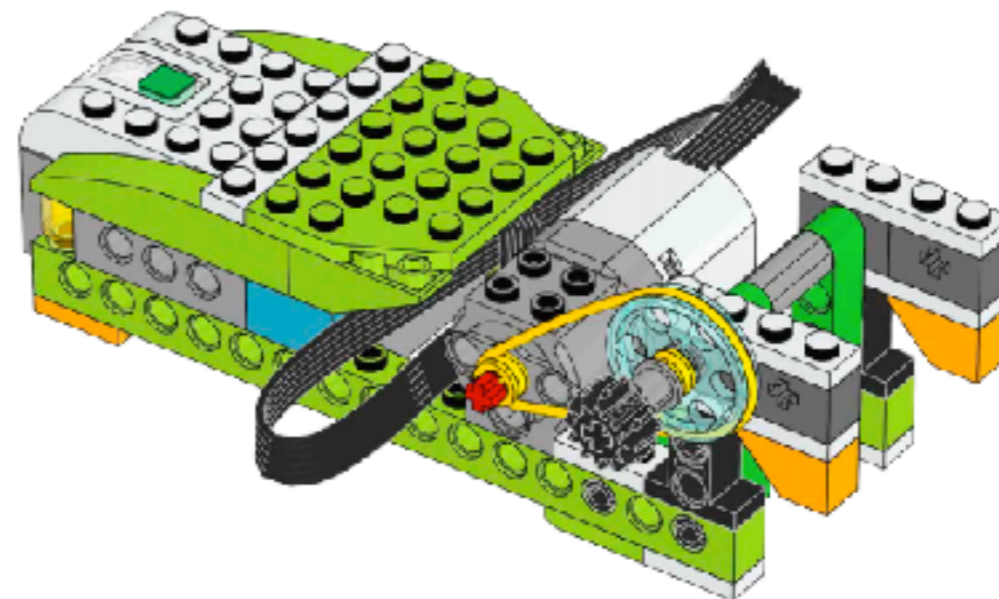

32

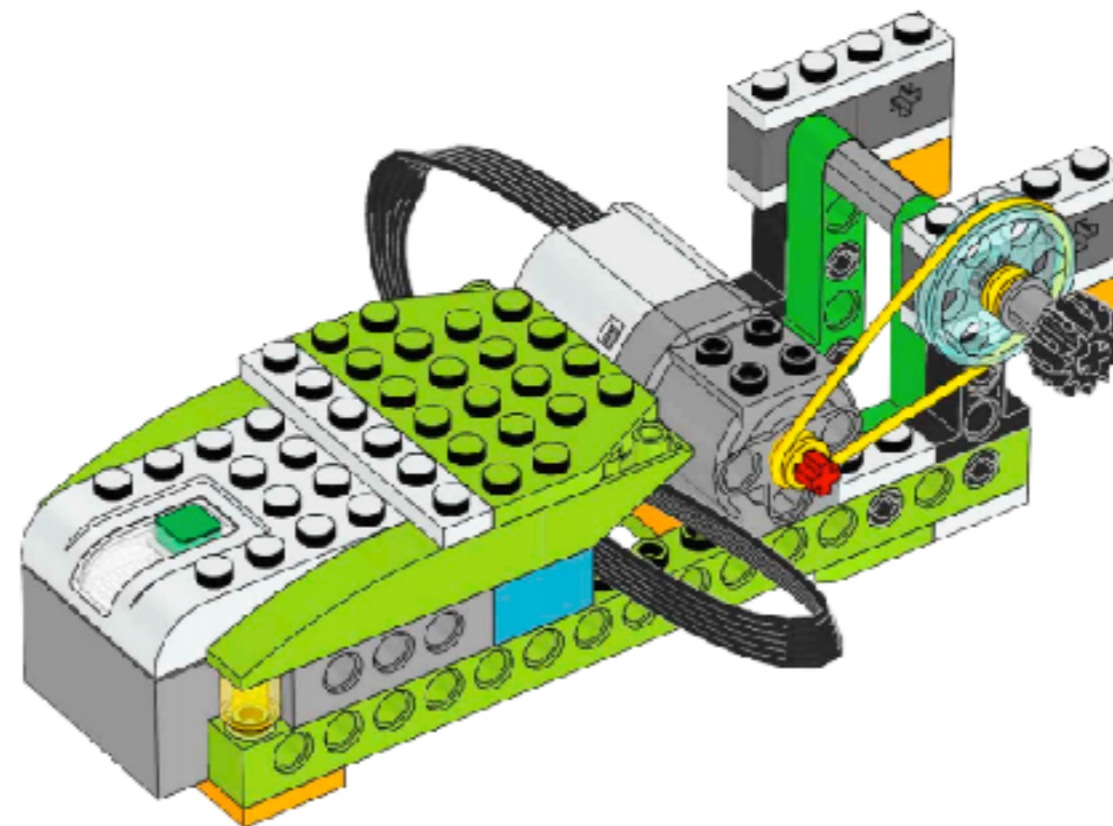

BRAVO!