

Robot marcheur

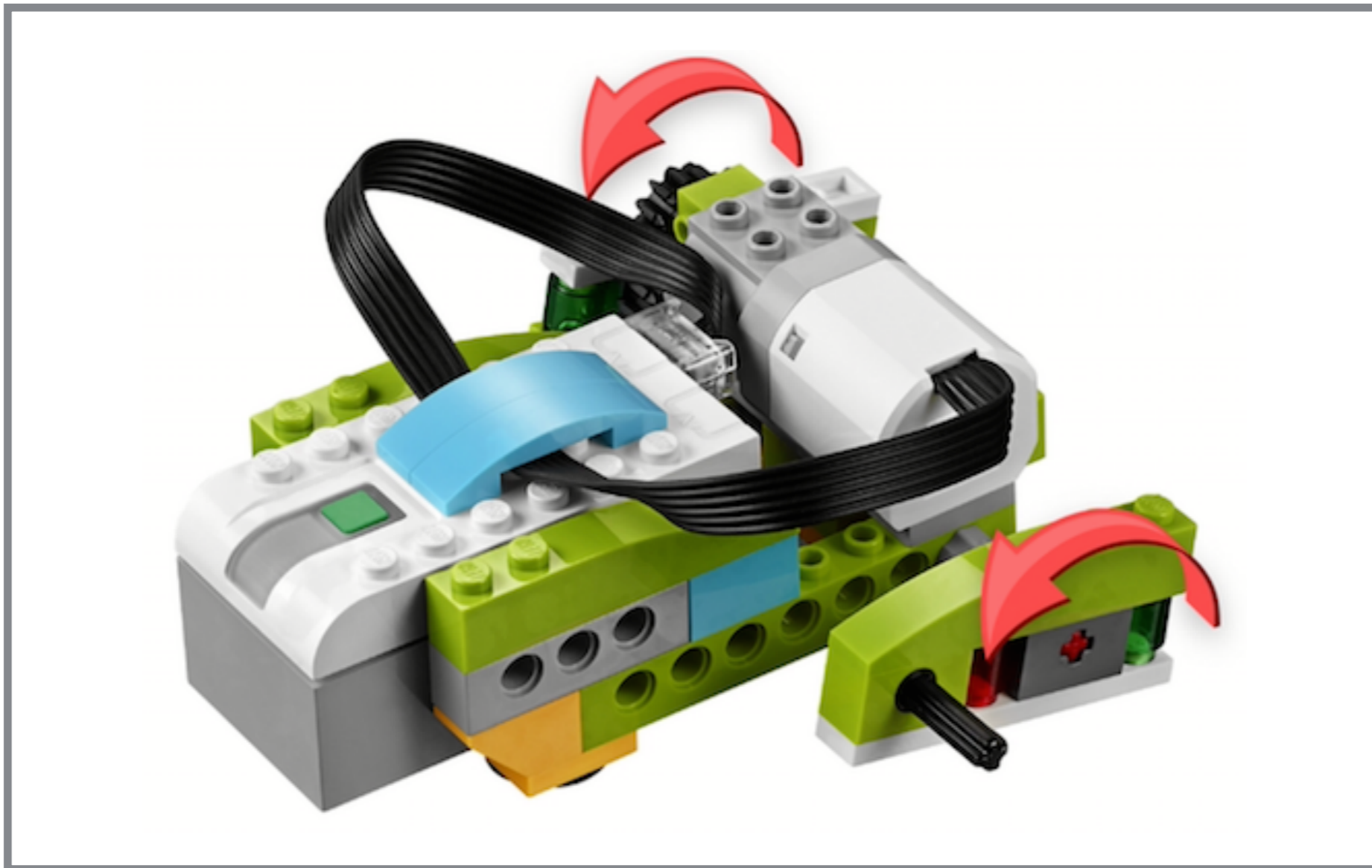

WeDo 2.0 de LEGO Education

Modification et bonification des plans par le Service national du RÉCIT à l'éducation préscolaire

Lynda O'Connell, conseillère pédagogique en TIC et Isabelle Therrien, enseignante à l'éducation préscolaire



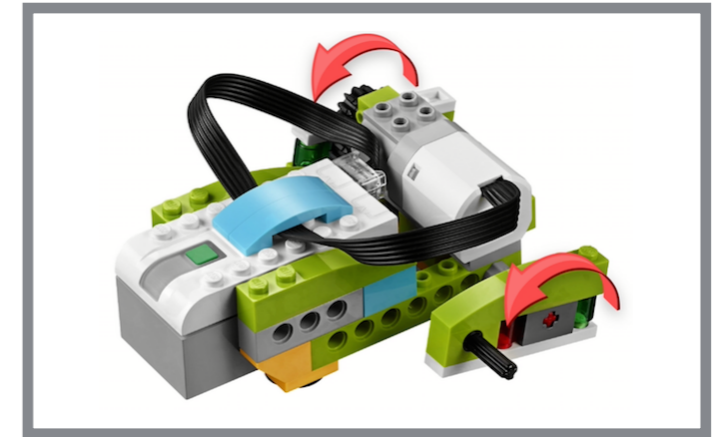

Nombre d'étapes : 20

Nom original du modèle : Walk

Genre de déplacement : Marche

INVENTAIRE DES PIÈCES

Robot marcheur 3

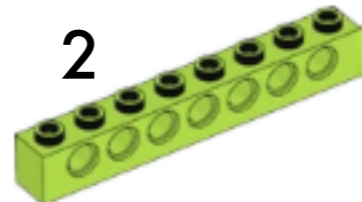
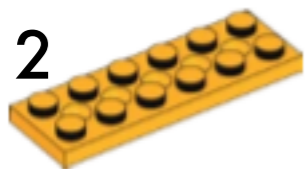
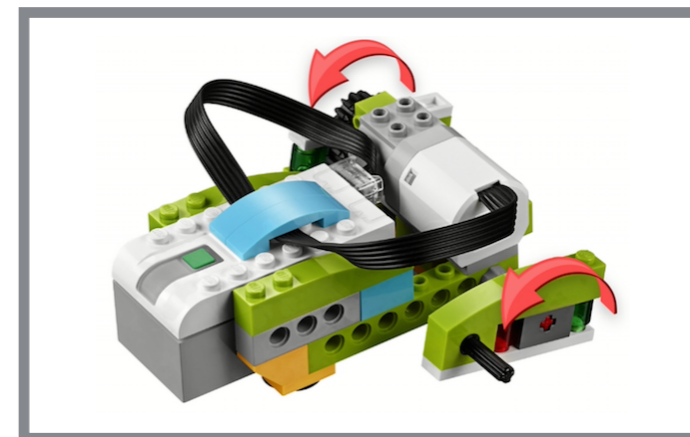

- ◆ 1 plaque percée, 2x6 (orange vif)
- ◆ 2 briques inclinées inversées, 1x2/45° (orange vif)

1

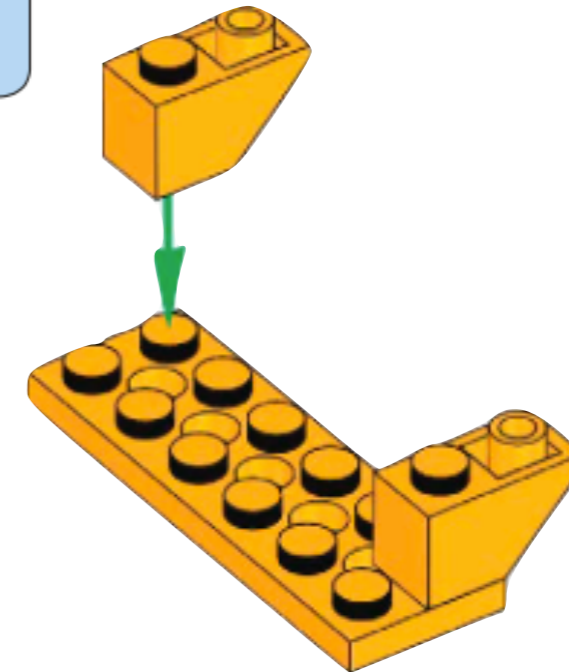
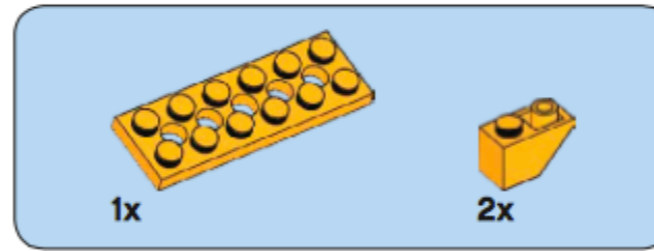

- ◆ 2 poutres perforées, 1x8 (vert citron)

2

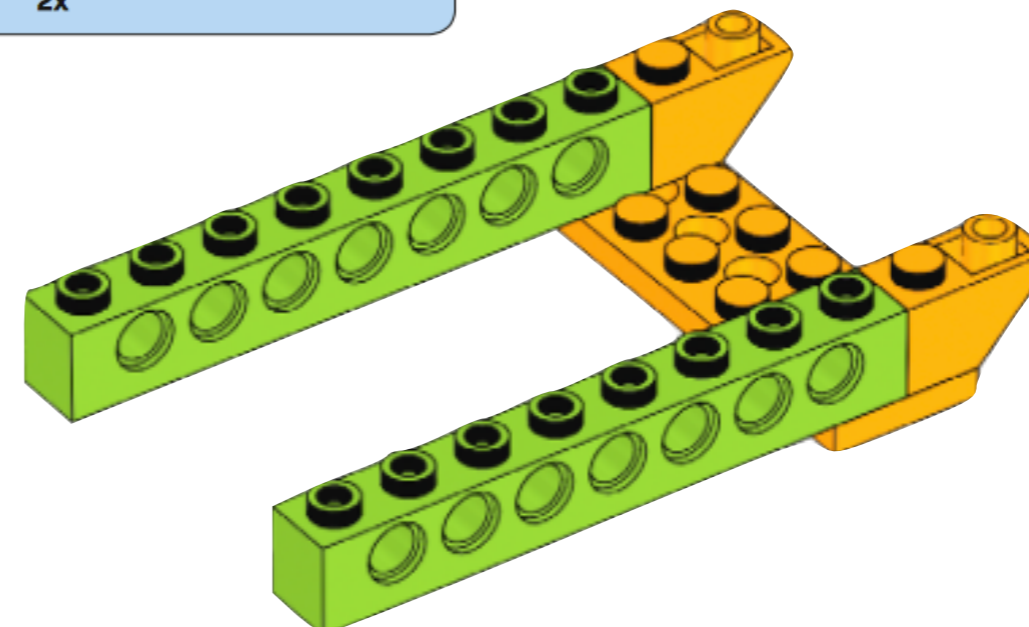
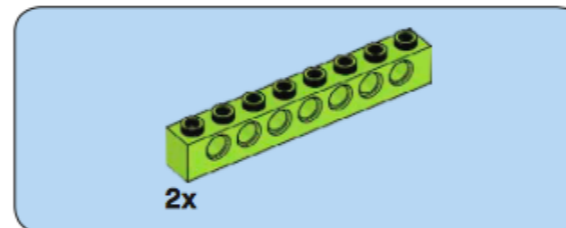

◆ 1 plaque percée, 2x6
(orange vif)

3

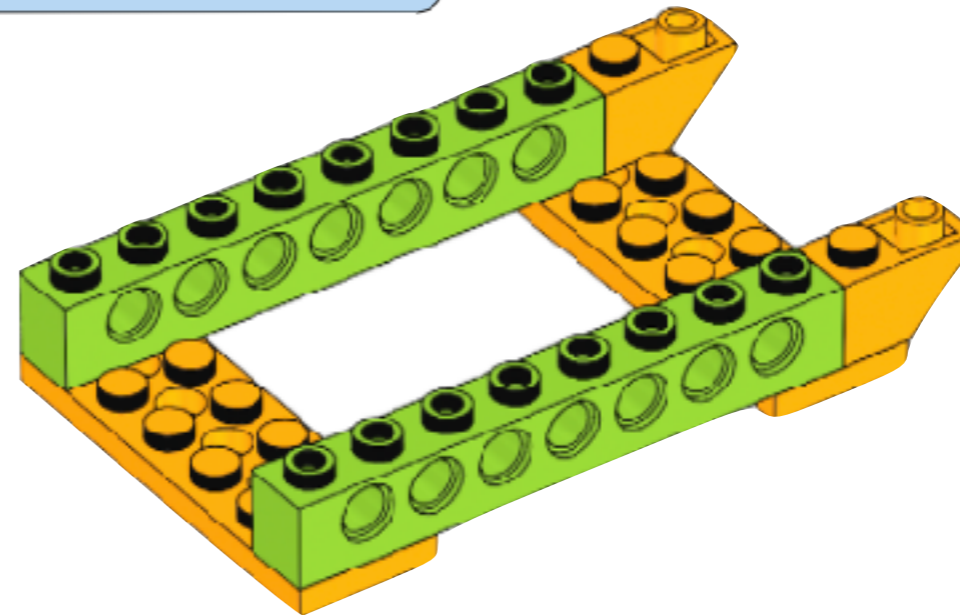
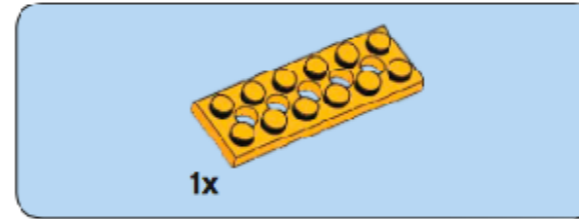

◆ 2 poutres perforées,
1x4 (vert citron)

4

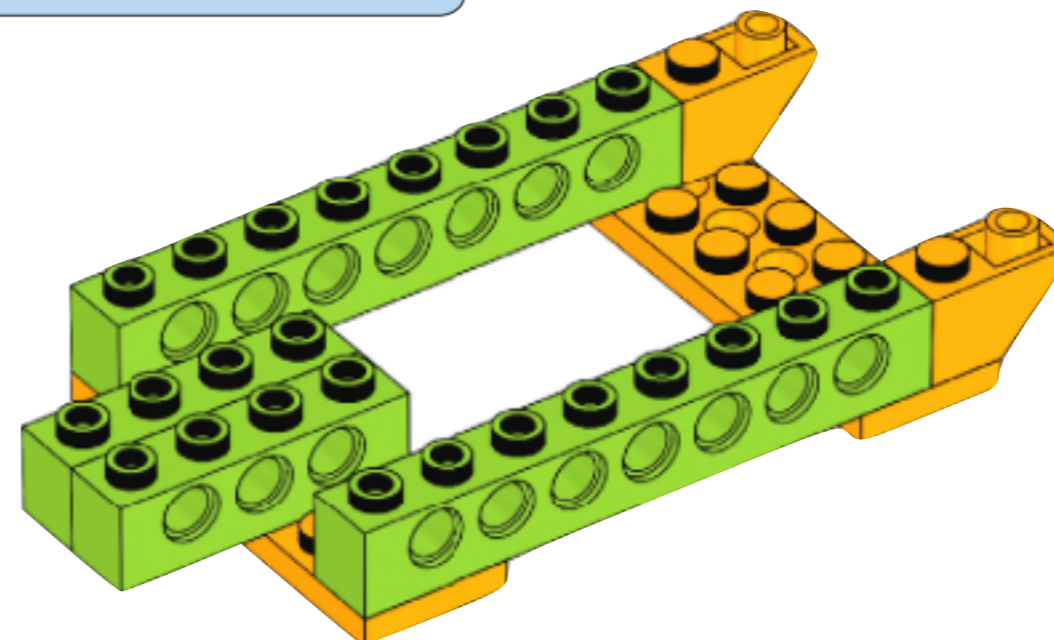
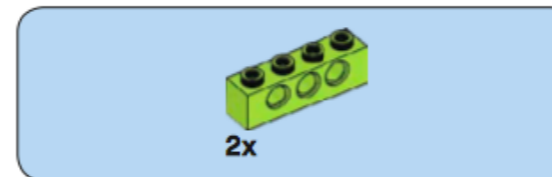

◆ 1 brique intelligente

5

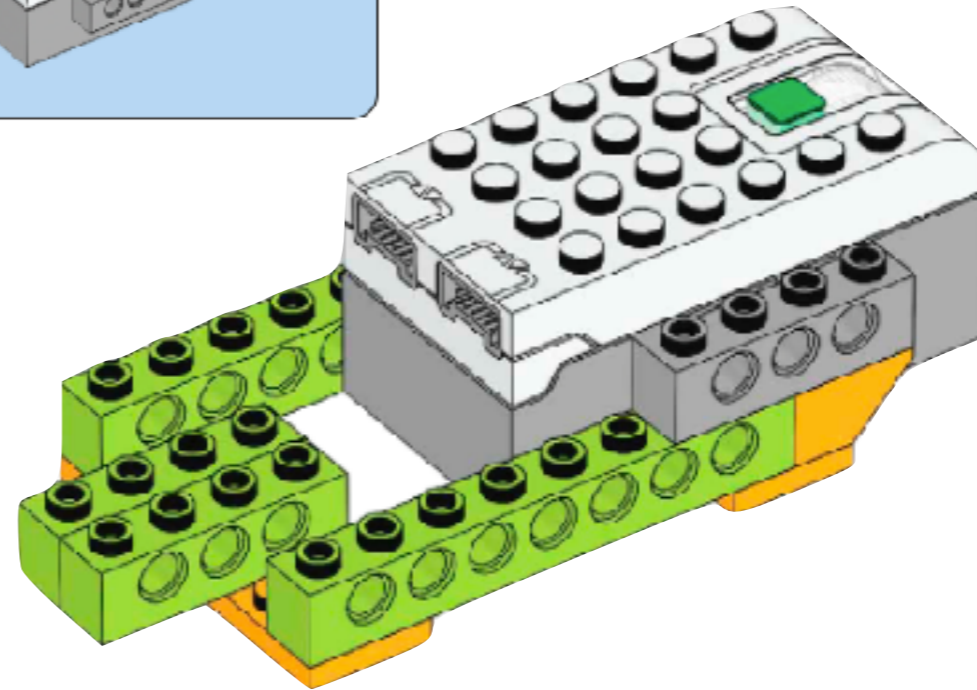
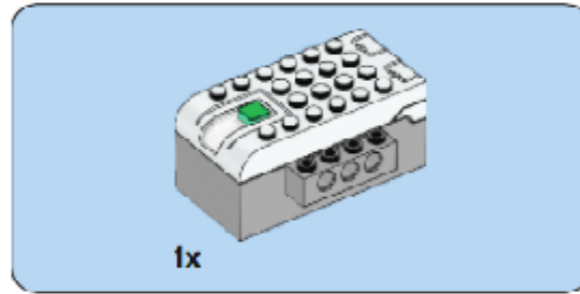

◆ 2 briques, 1x2 (bleu azur)

6

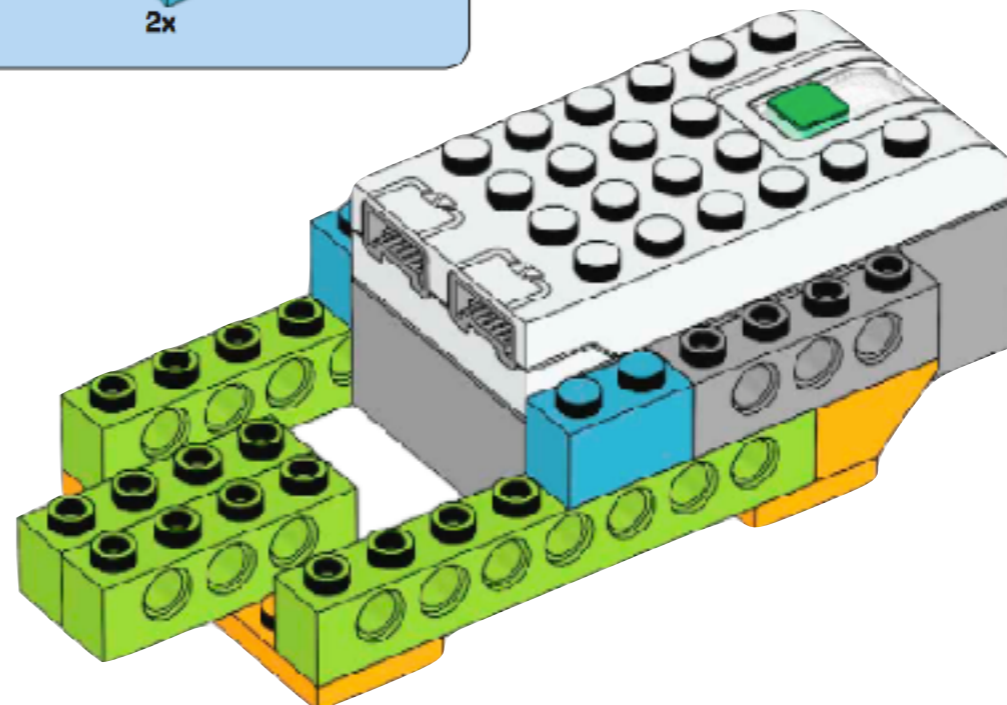
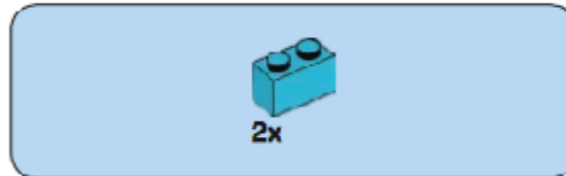

◆ 2 briques incurvées,
1x6 (vert citron)

7

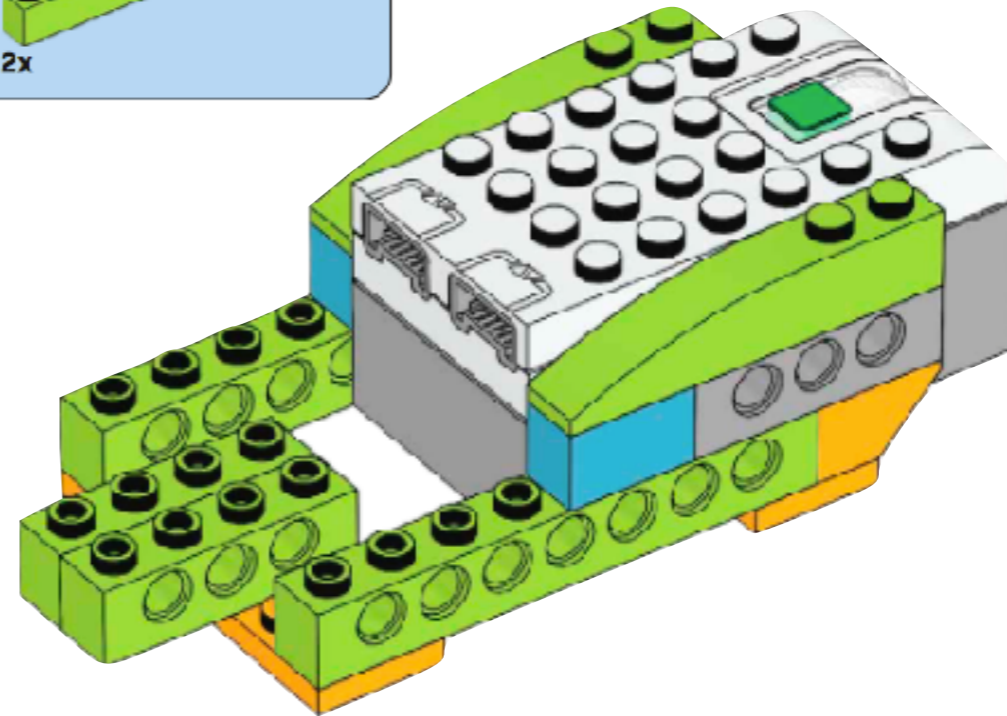
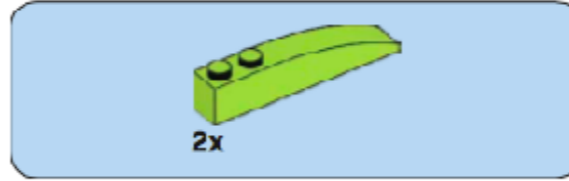

◆ 1 moteur moyen (blanc)

8

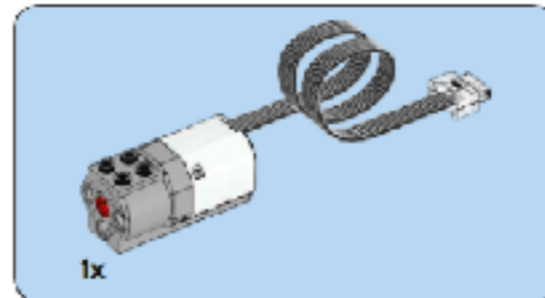

8

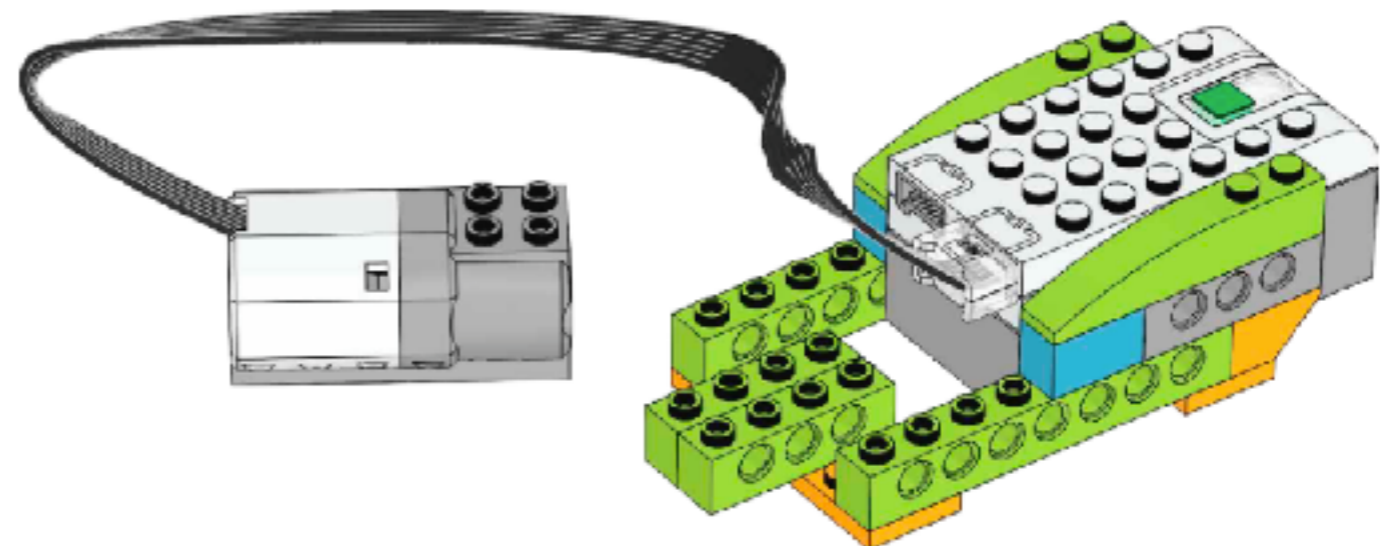

- ◆ 2 plaques incurvées, 1x4x2/3 (bleu azur)

9

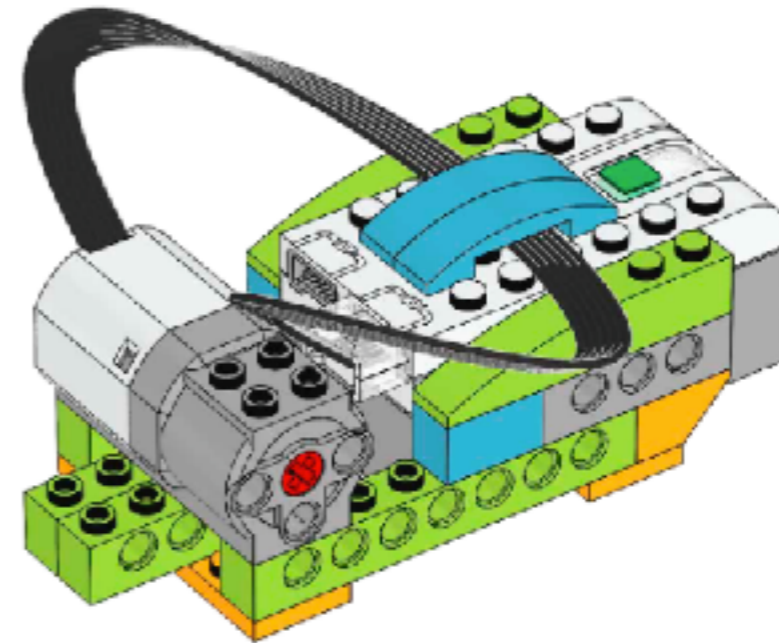
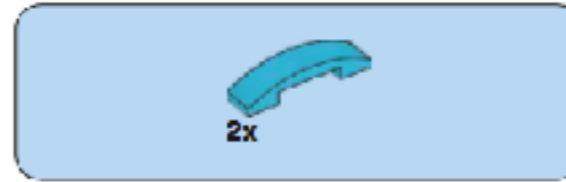

- ◆ 1 cheville à friction, 2 modules (noir)

- ◆ 1 axe, 3 modules (gris)

10

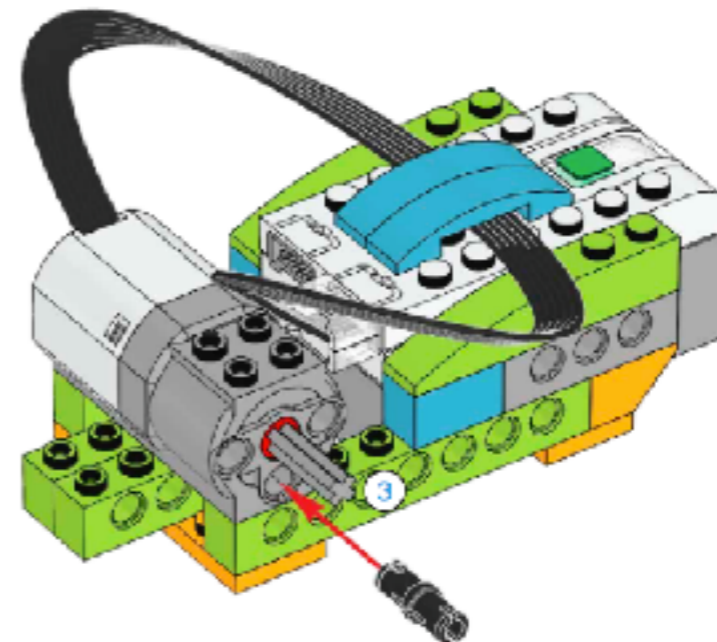
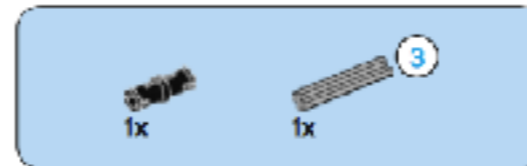

- ◆ 1 poutre perforée, 1x4 (vert citron)

11

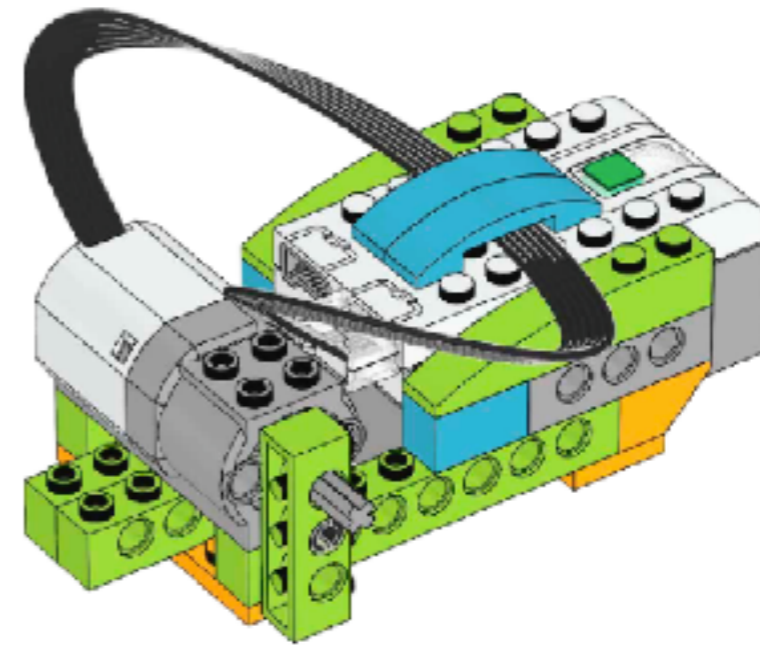
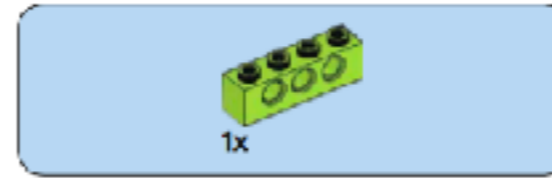

- ◆ 1 axe, 10 modules (noir)
- ◆ 1 bague/allonge d'axe, 2 modules (gris)
- ◆ 1 axe, 2 modules (rouge)

12

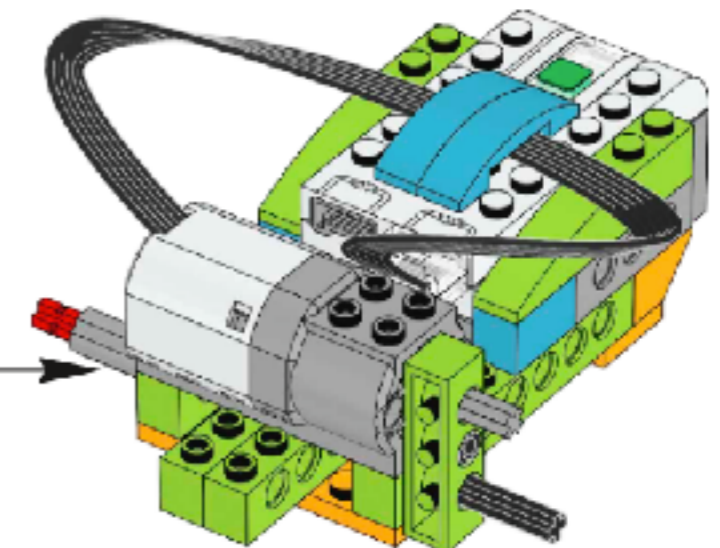
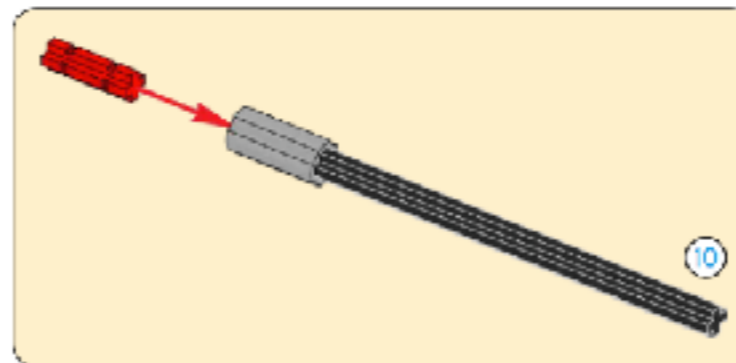
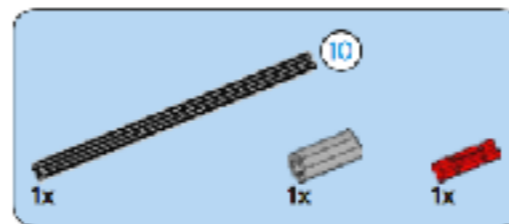

- ◆ 1 double engrenage conique, 12 dents (noir)
- ◆ 1 double engrenage conique, 20 dents (noir)

13

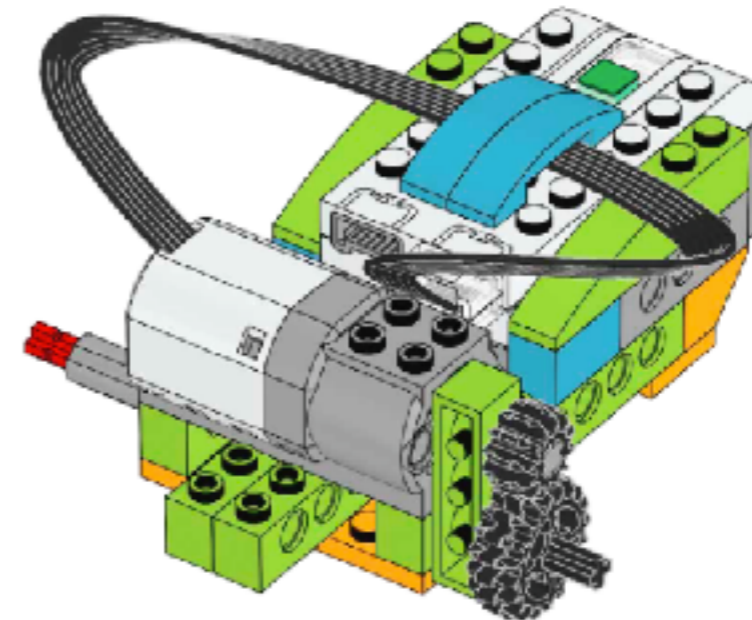
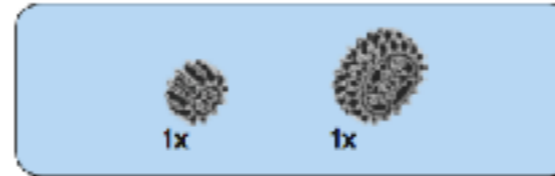

- ◆ 4 plaques de protection, 2x2 (noir)

14

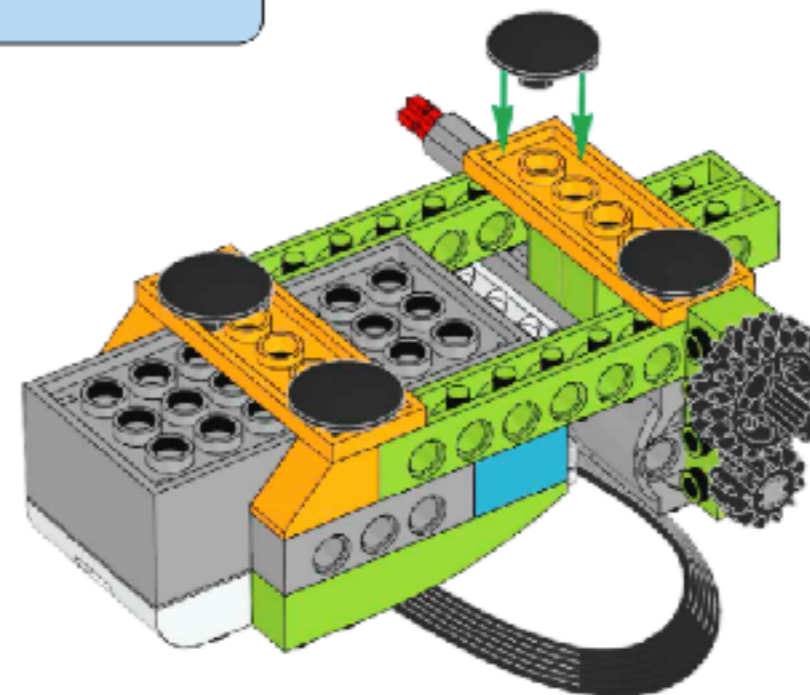

- ◆ 1 plaque, 1x6 (blanc)
- ◆ 1 brique ronde, 1x1 (vert transparent)

15

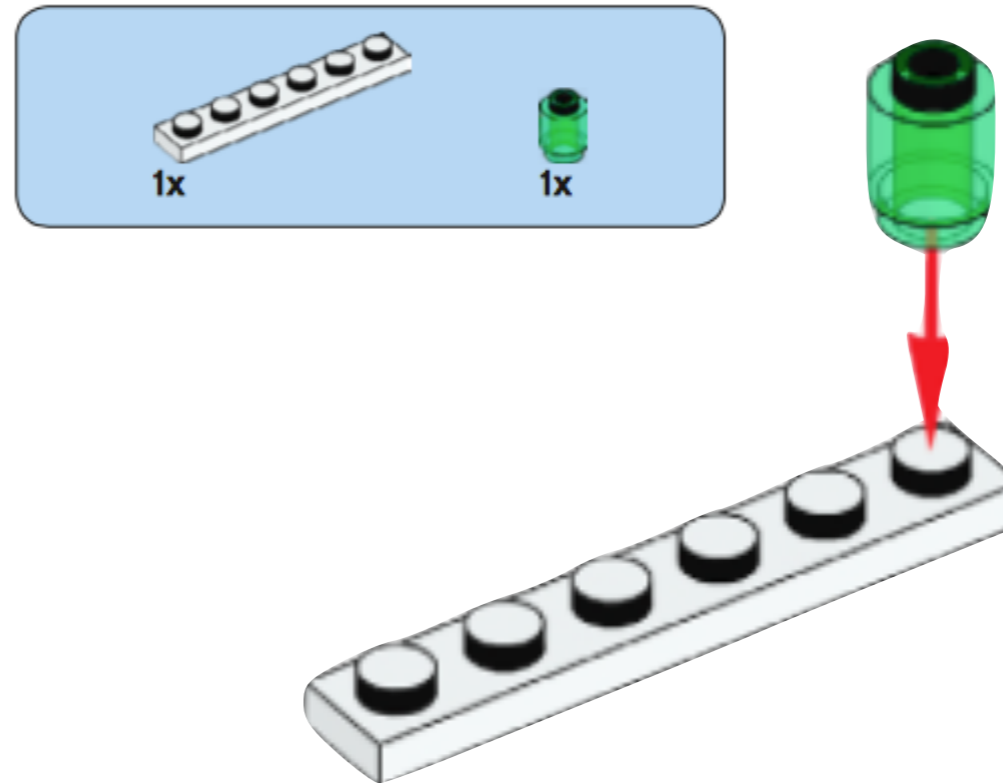

- ◆ 1 brique ronde, 1x1 (rouge transparent)
- ◆ 1 poutre perforée avec trou en croix, 1x2 (gris foncé)
- ◆ 1 poutre perforée, 1x2 (vert citron)

16

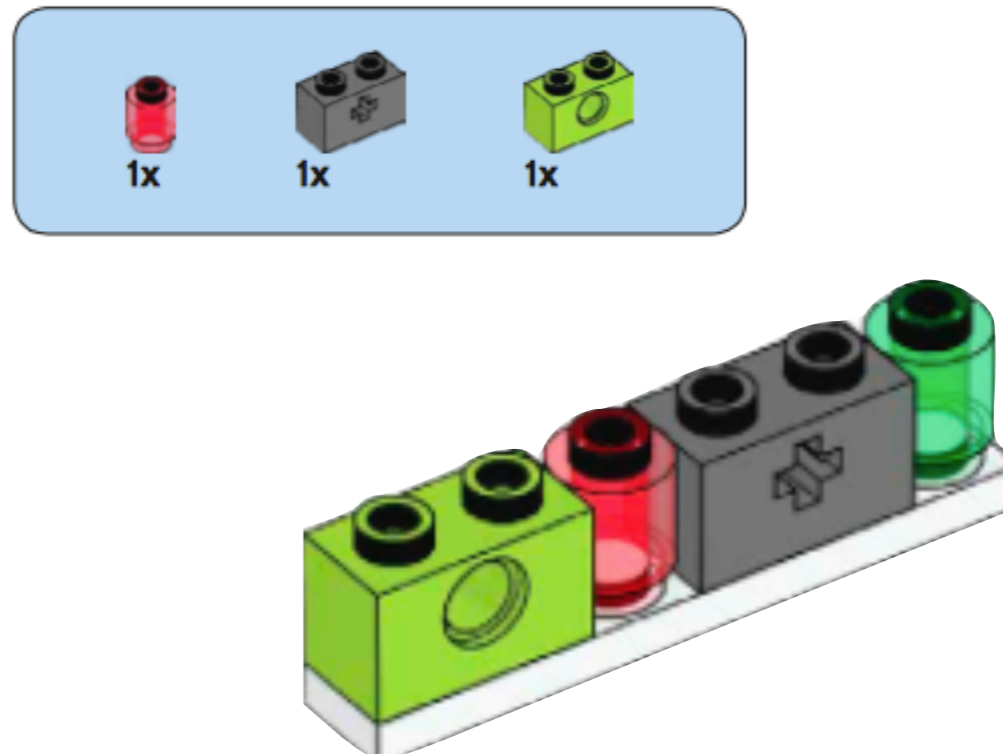

◆ 1 brique incurvée, 1x6
(vert citron)

17

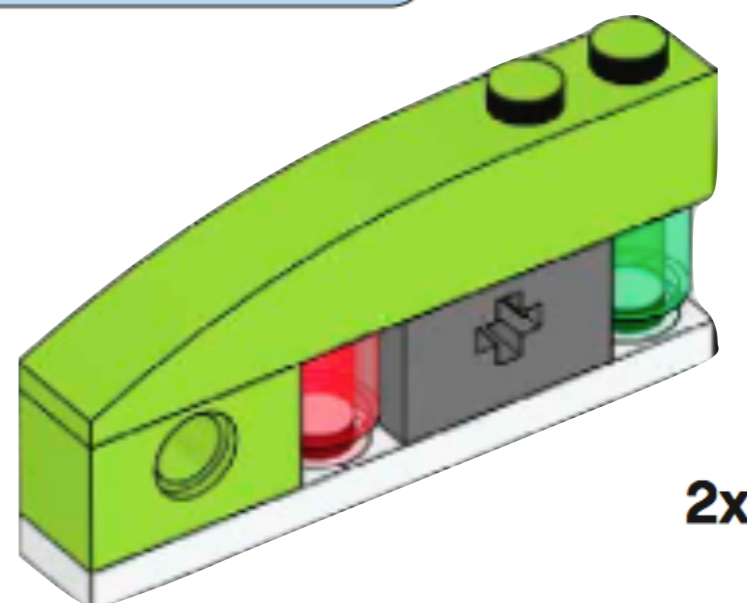
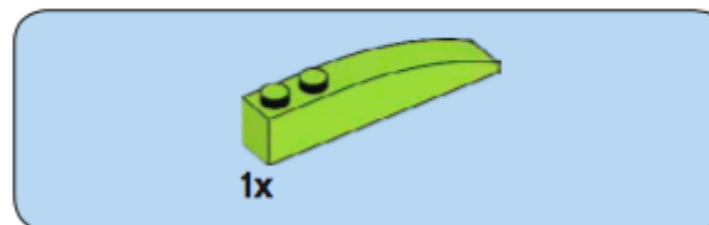

18

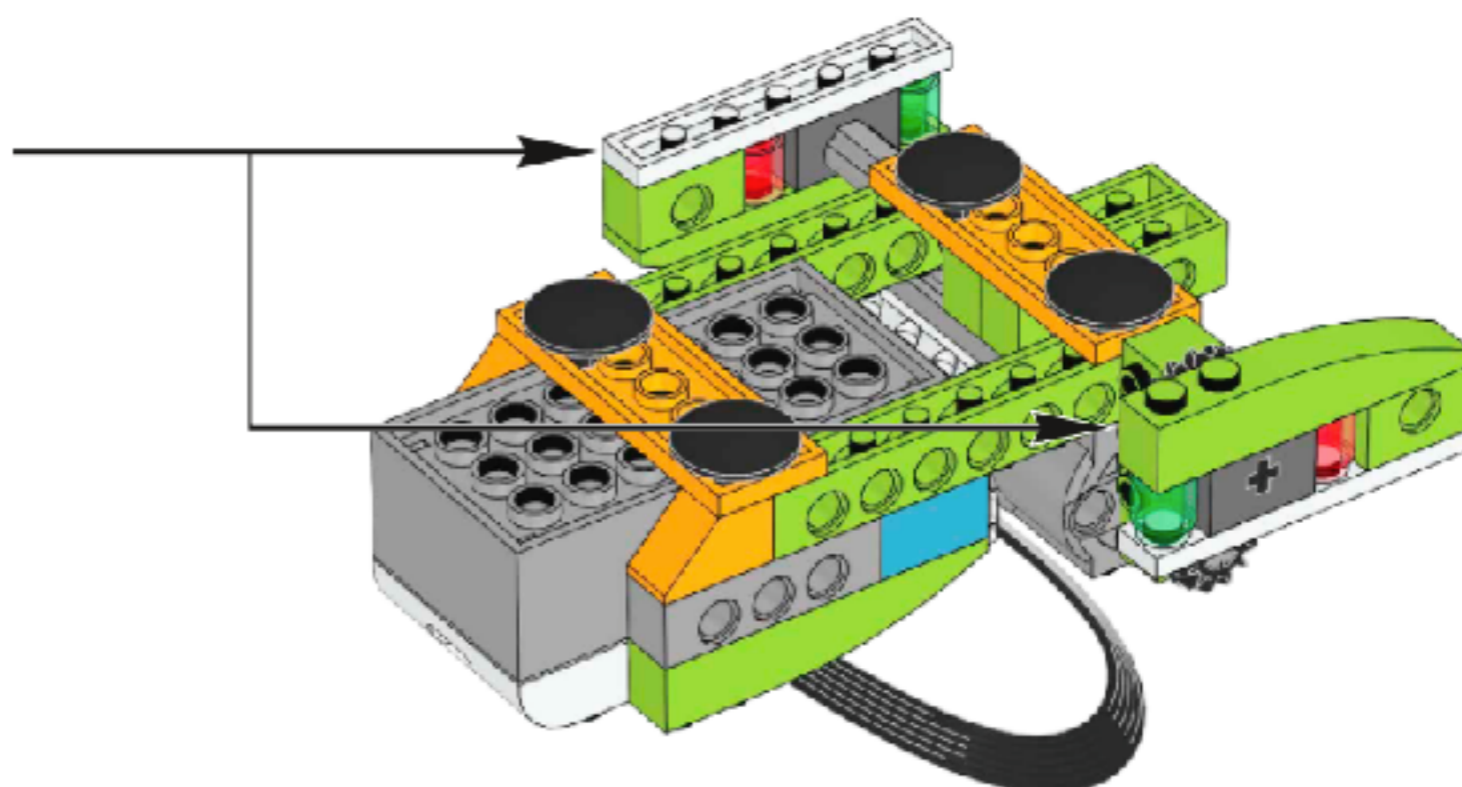

◆ 2 chevilles
d'assemblage avec axe,
3 modules (noir)

19

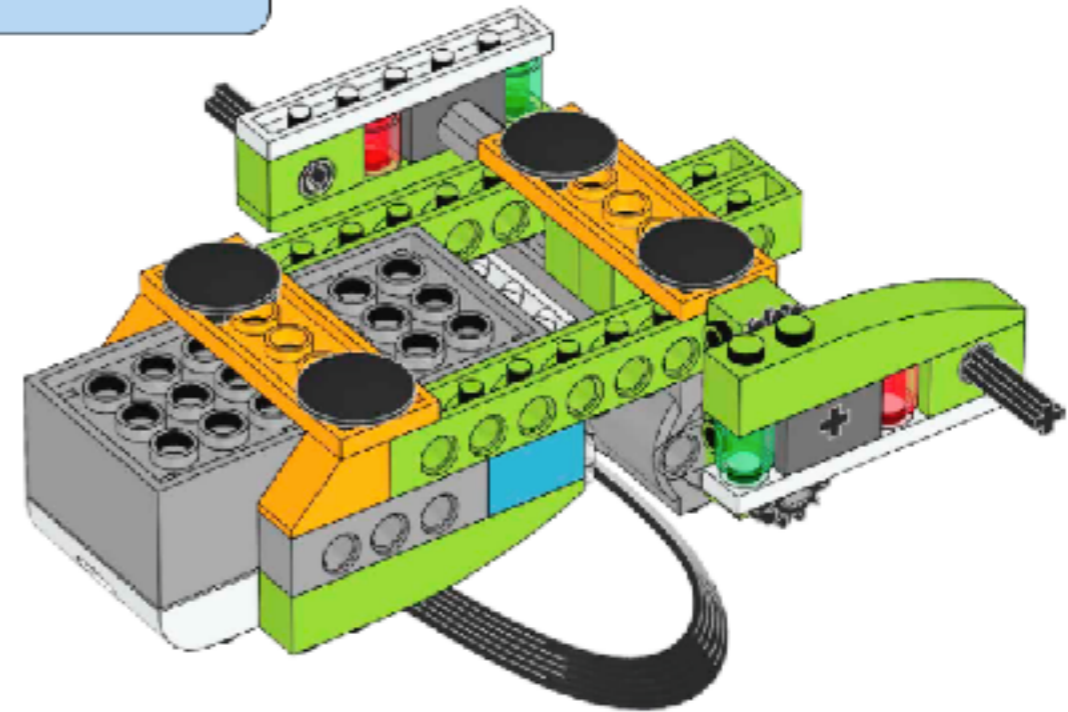
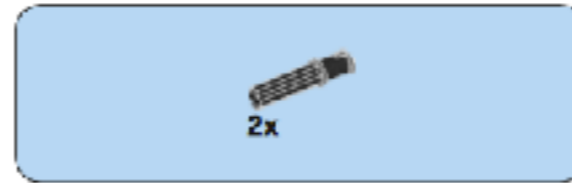

BRAVO!

20

