

1001

WeDo 2.0 Trein

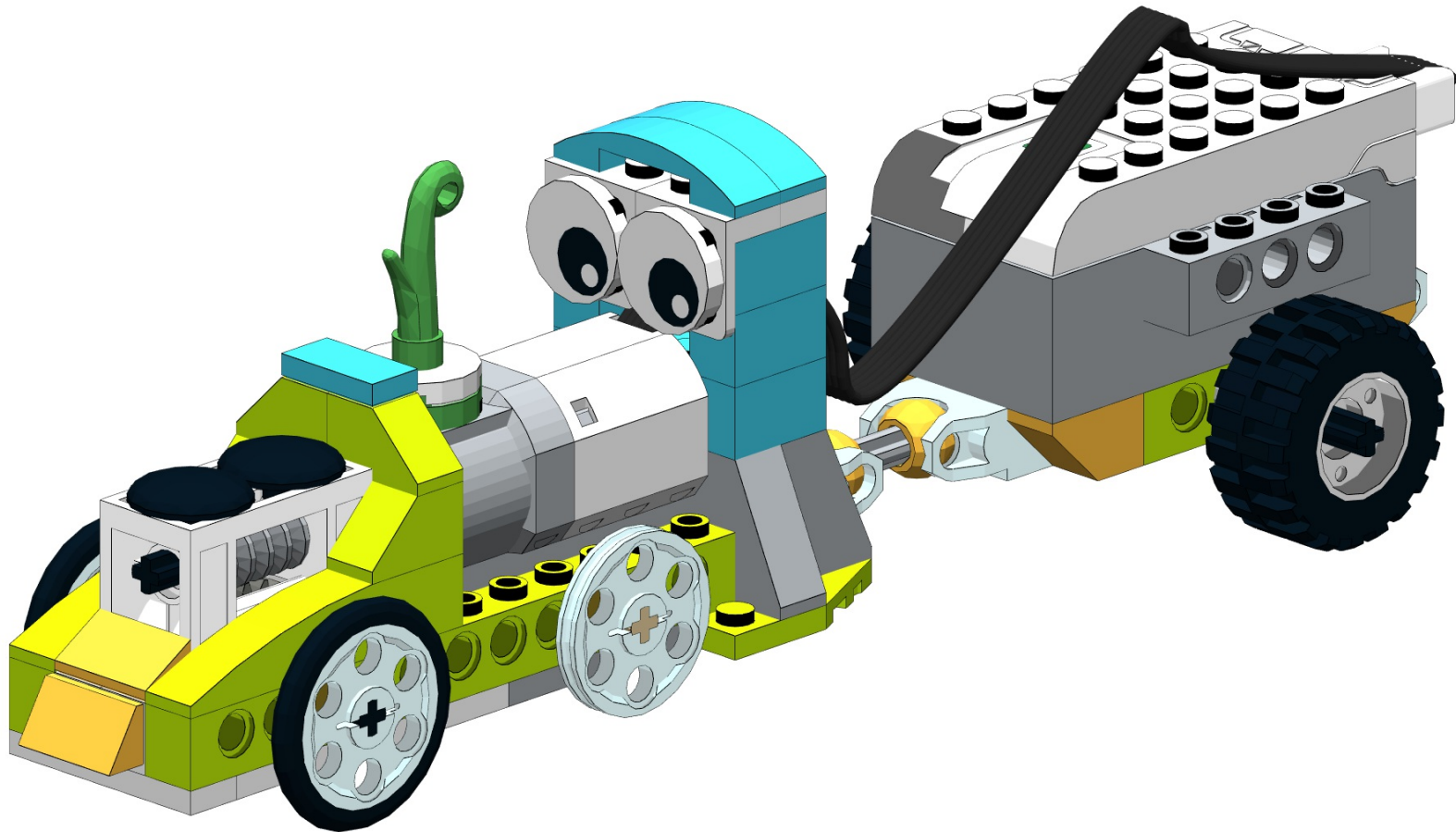

83 pcs.

26 Pages

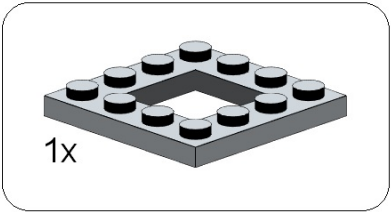
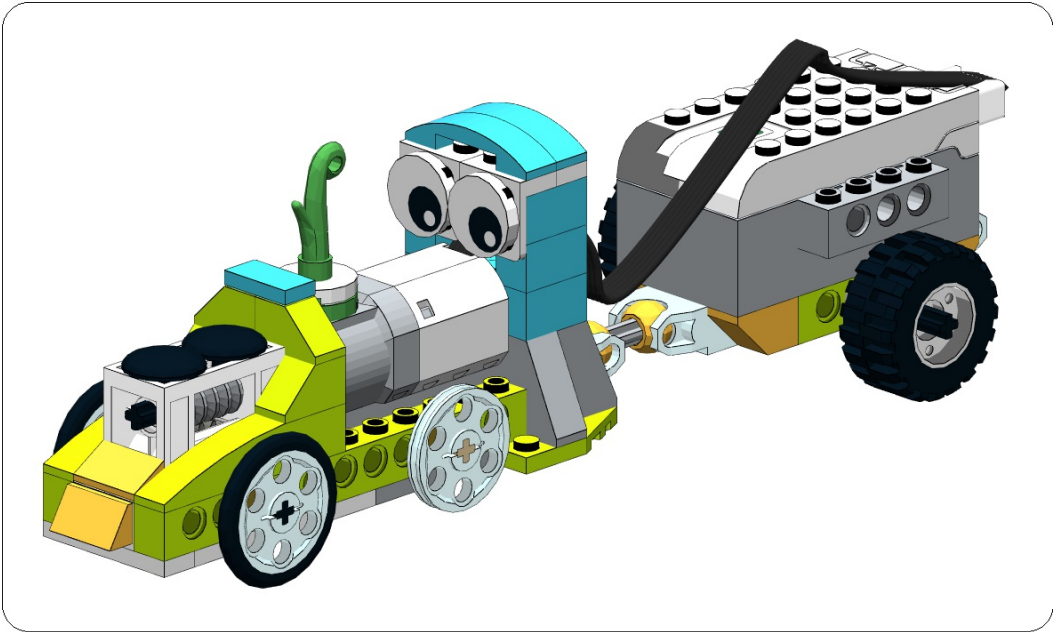

1

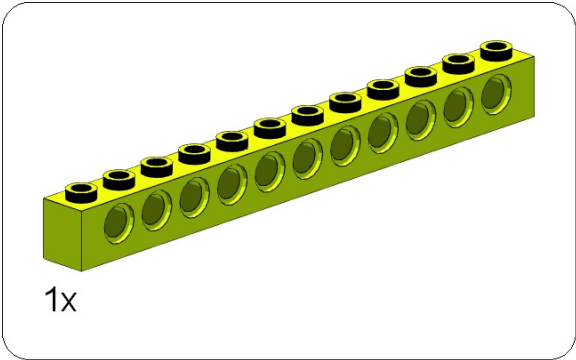
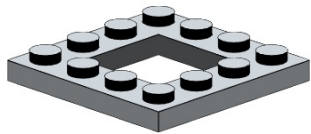

2

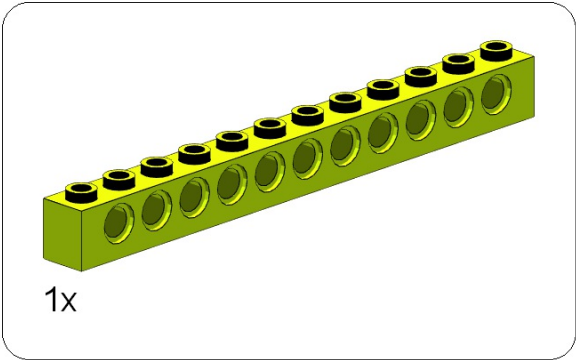
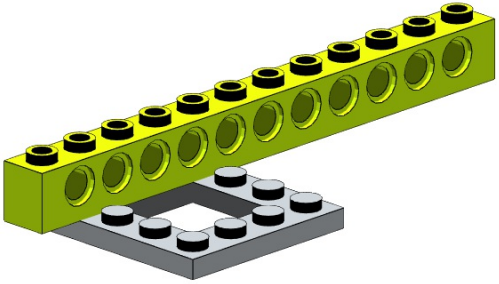

3

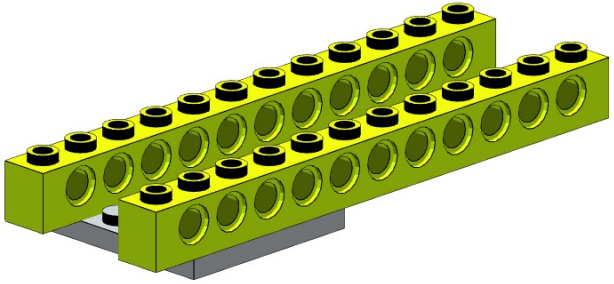

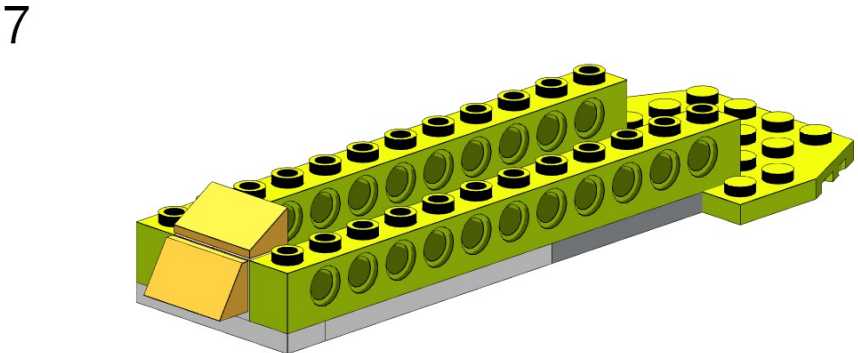
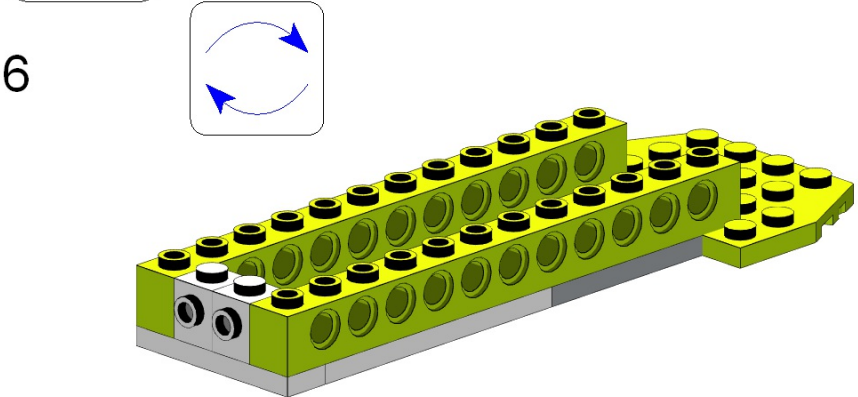
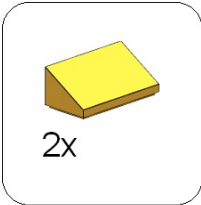
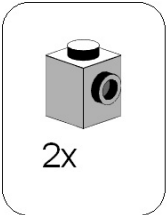
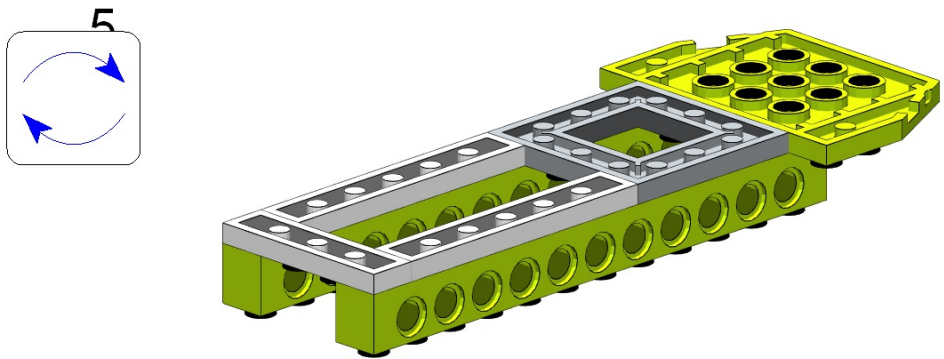
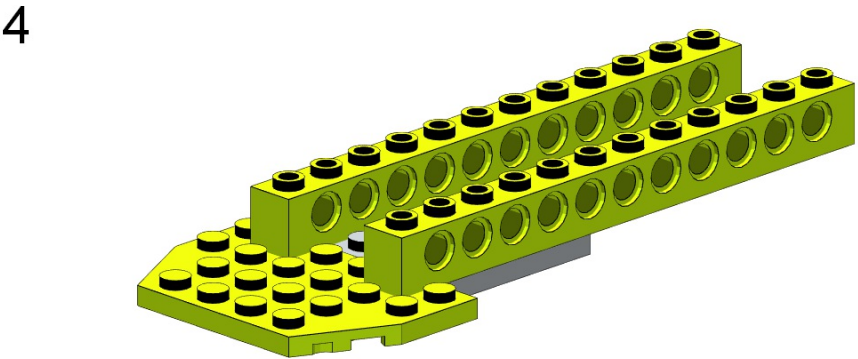
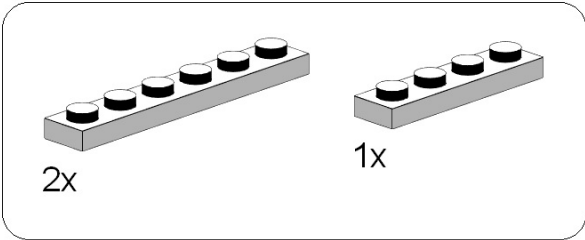
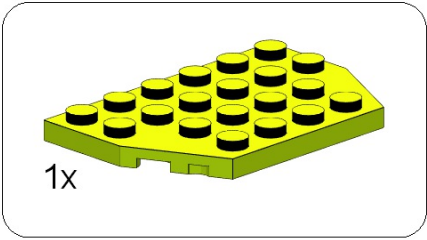

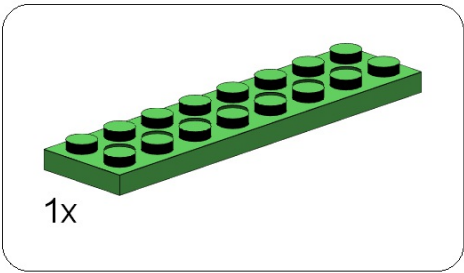

8

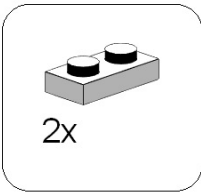
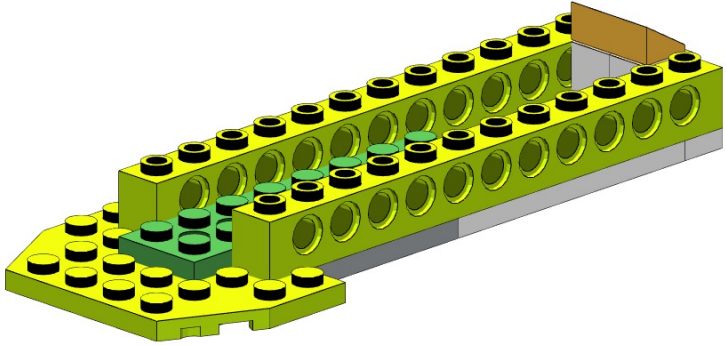

9

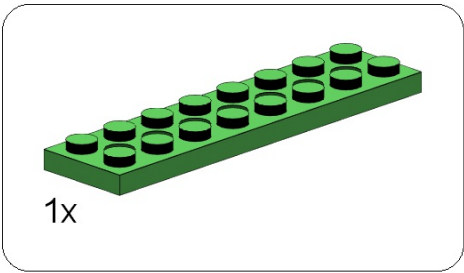
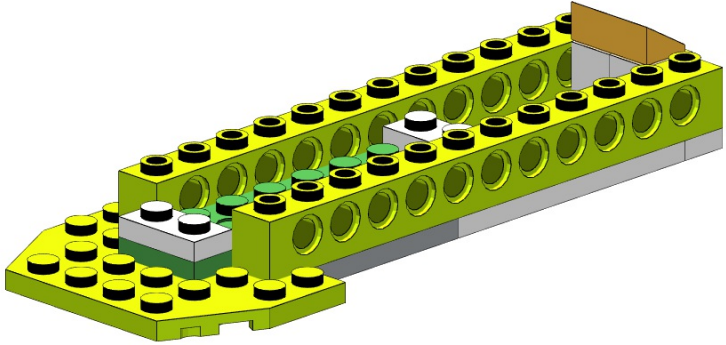

10

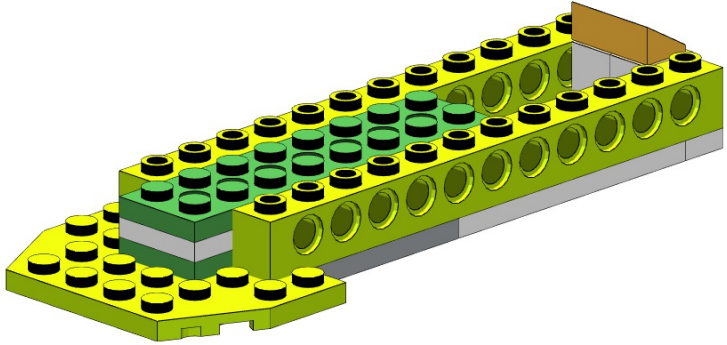

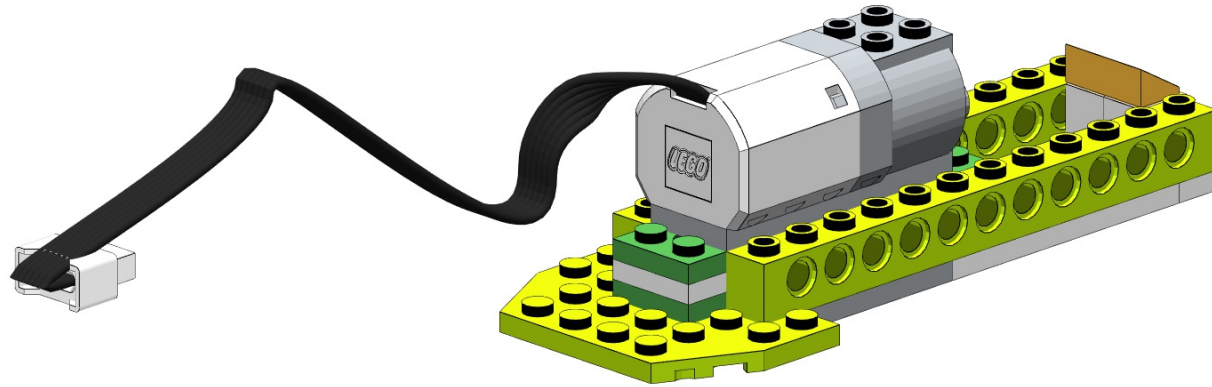

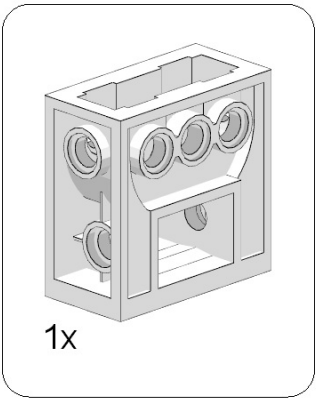

12

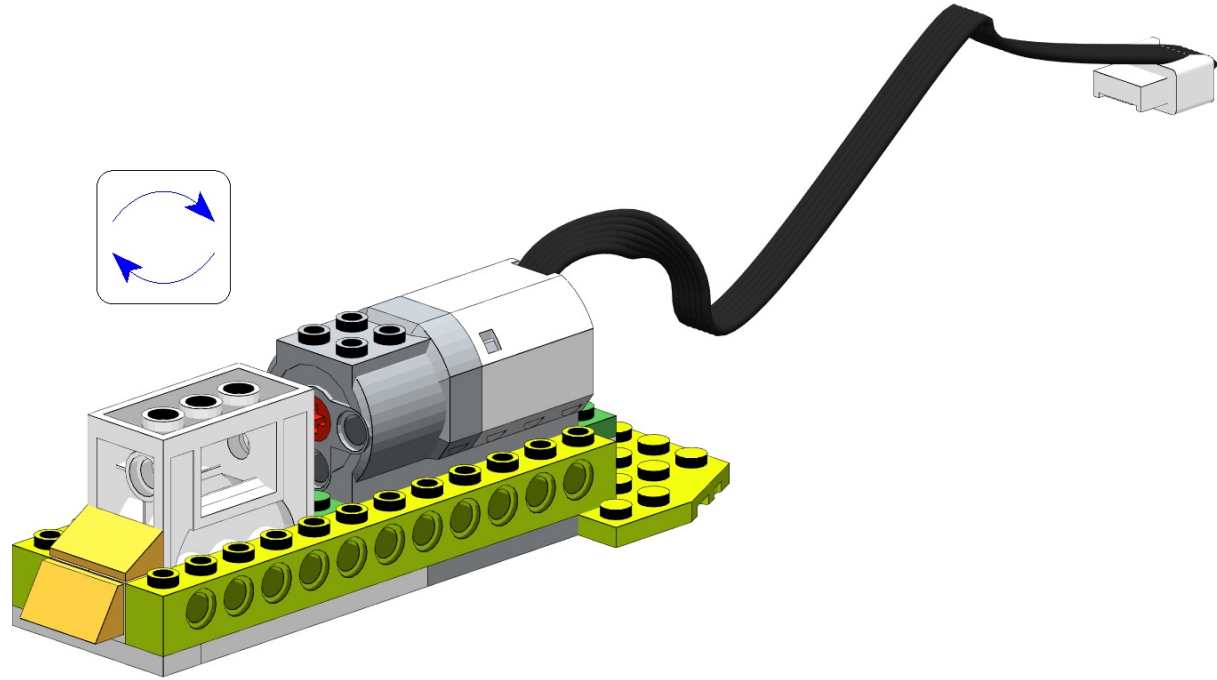

13

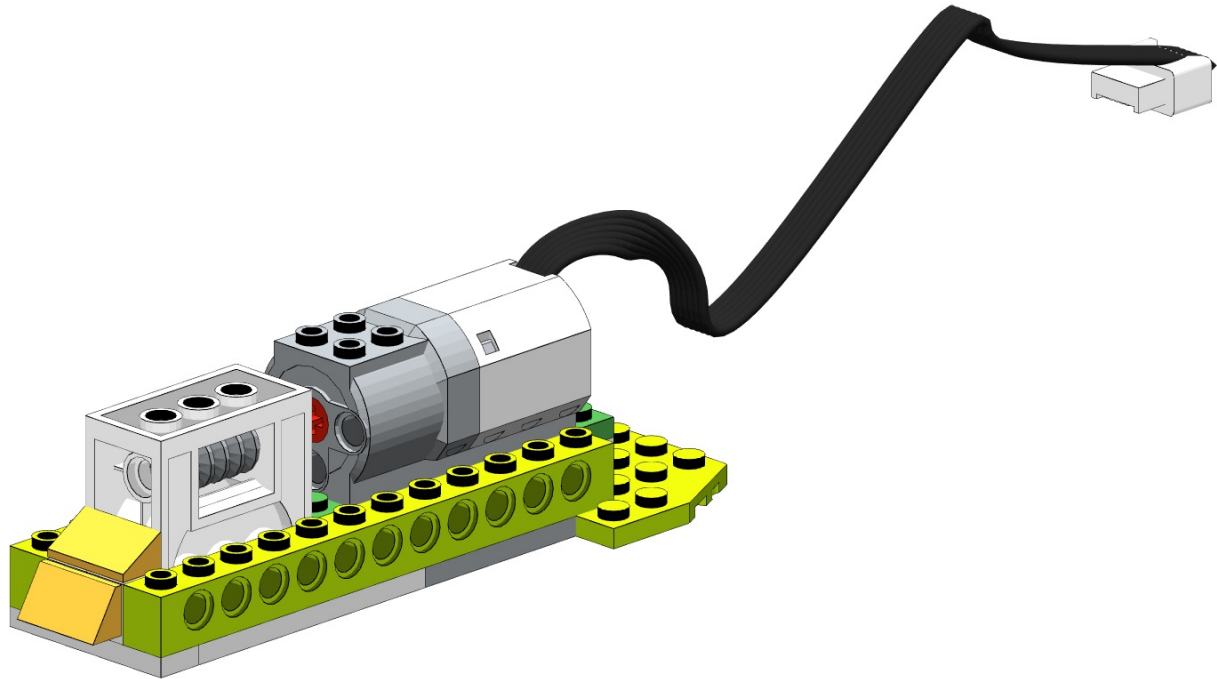

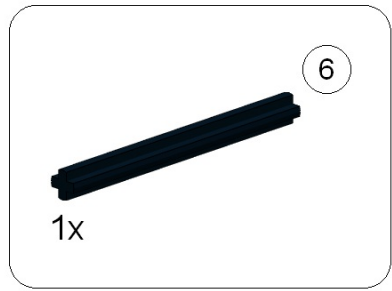

14

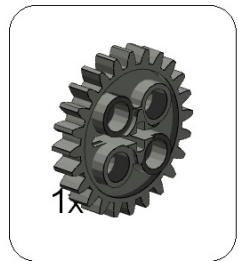
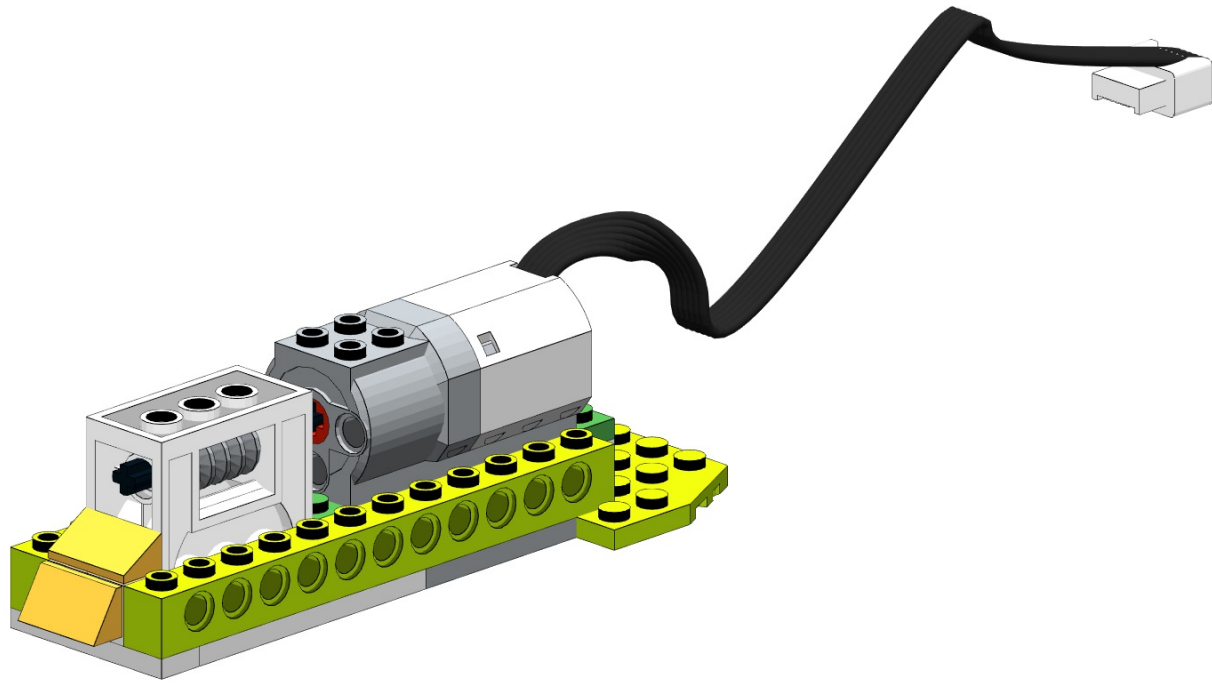

15

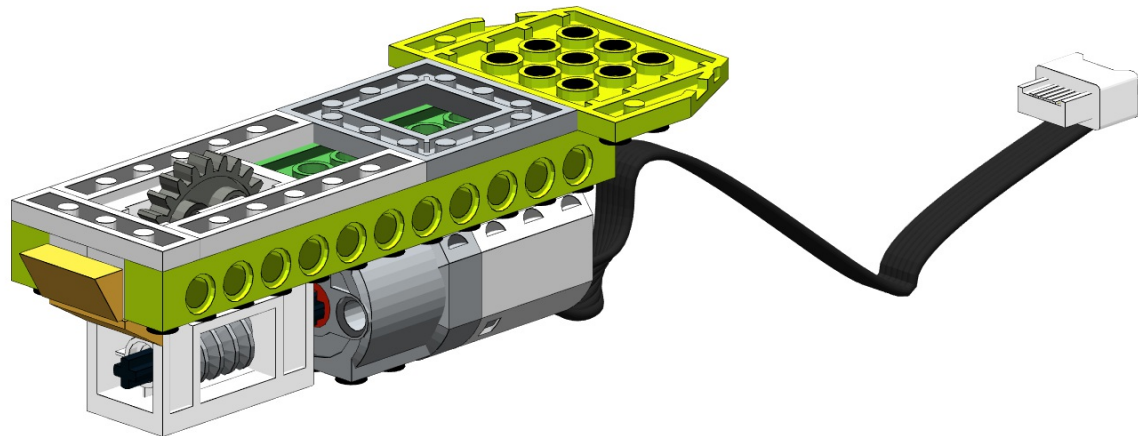
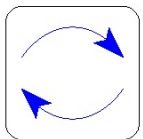

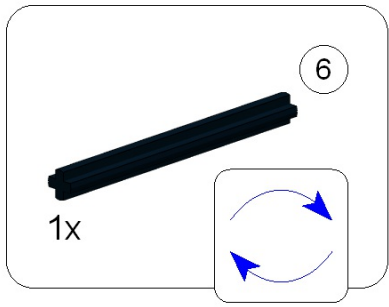

16

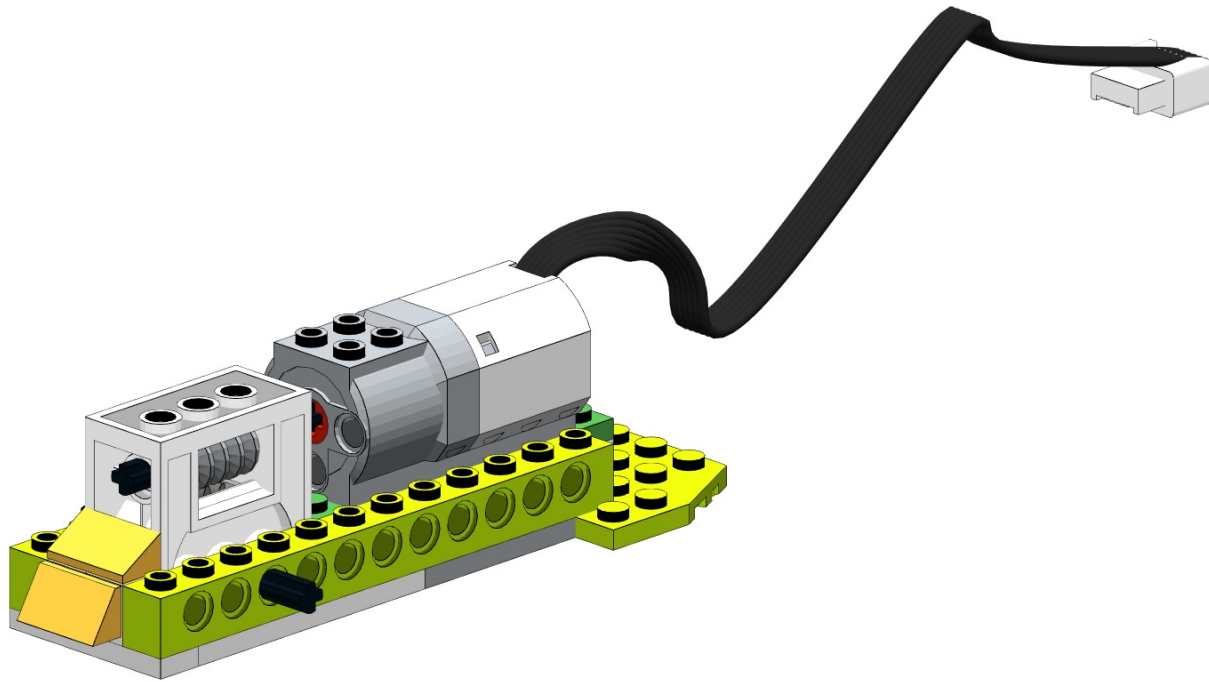

17

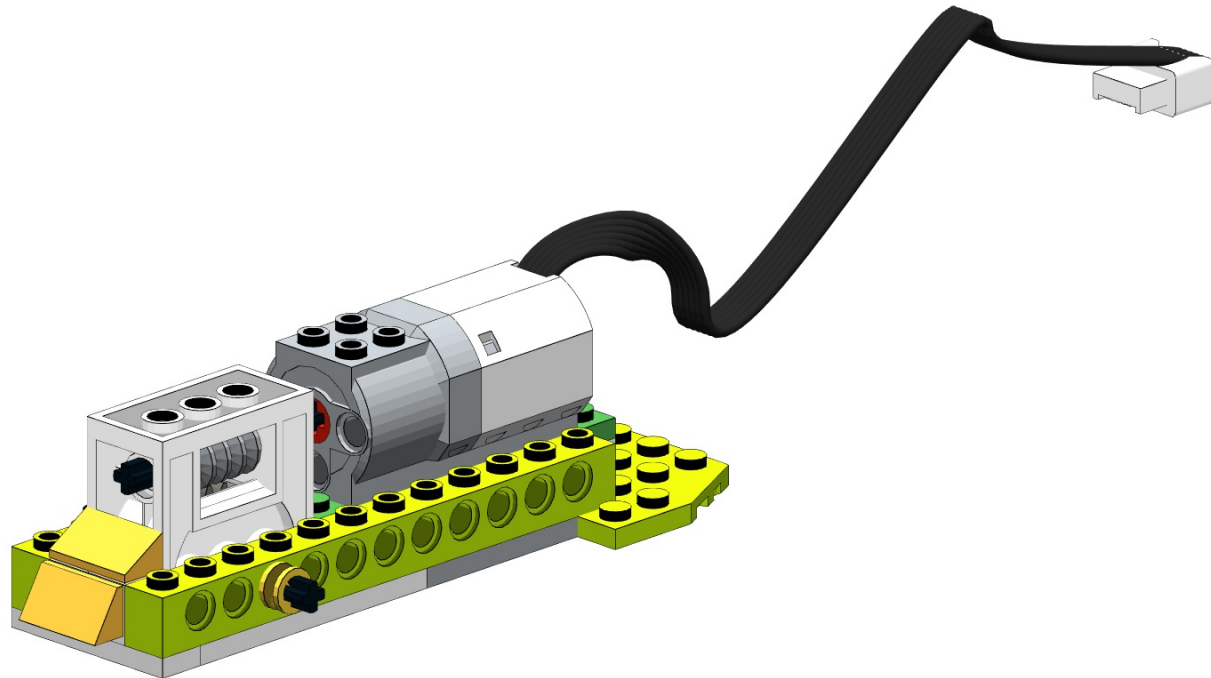

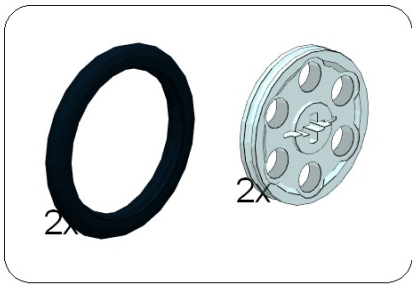

18

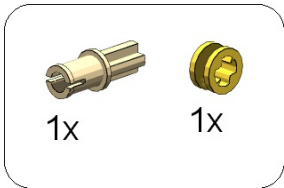
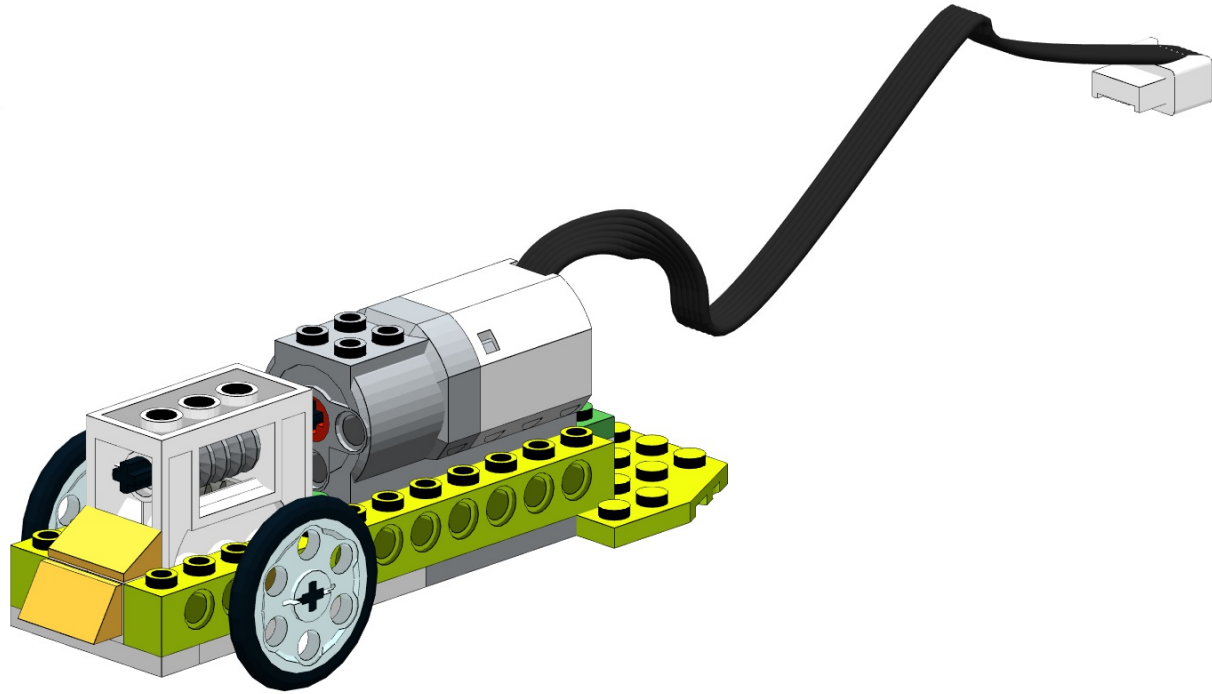

19

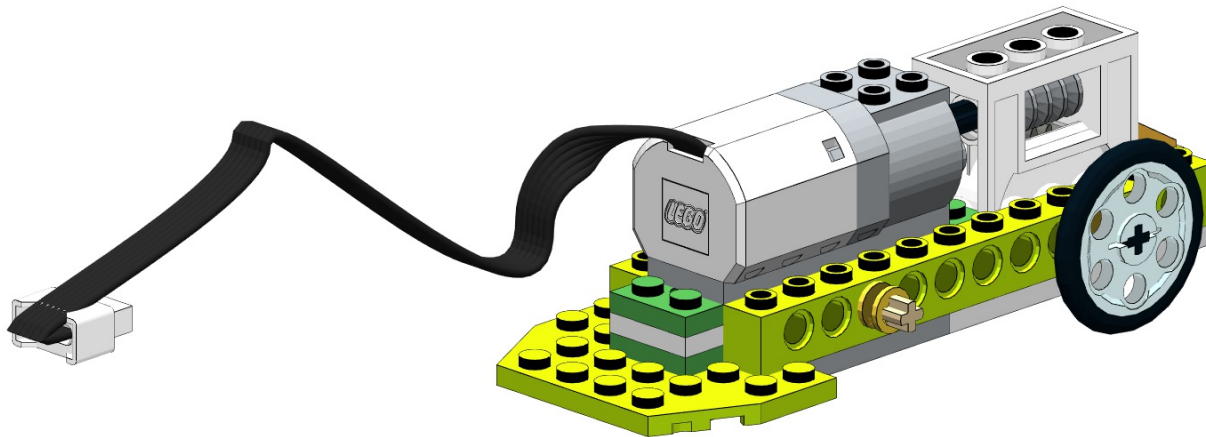
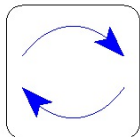

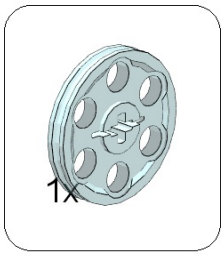

20

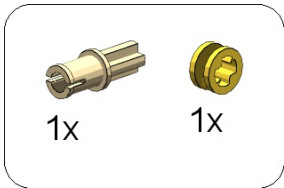
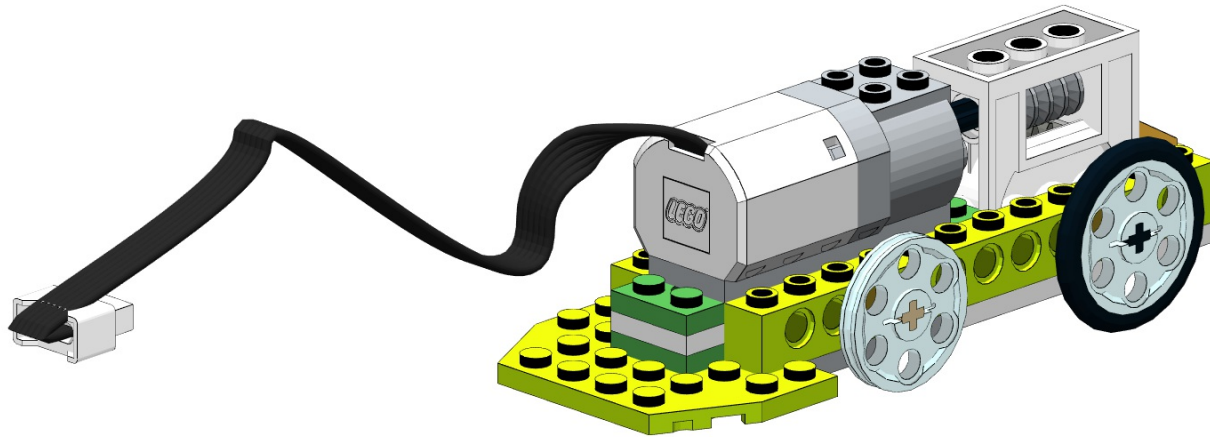

21

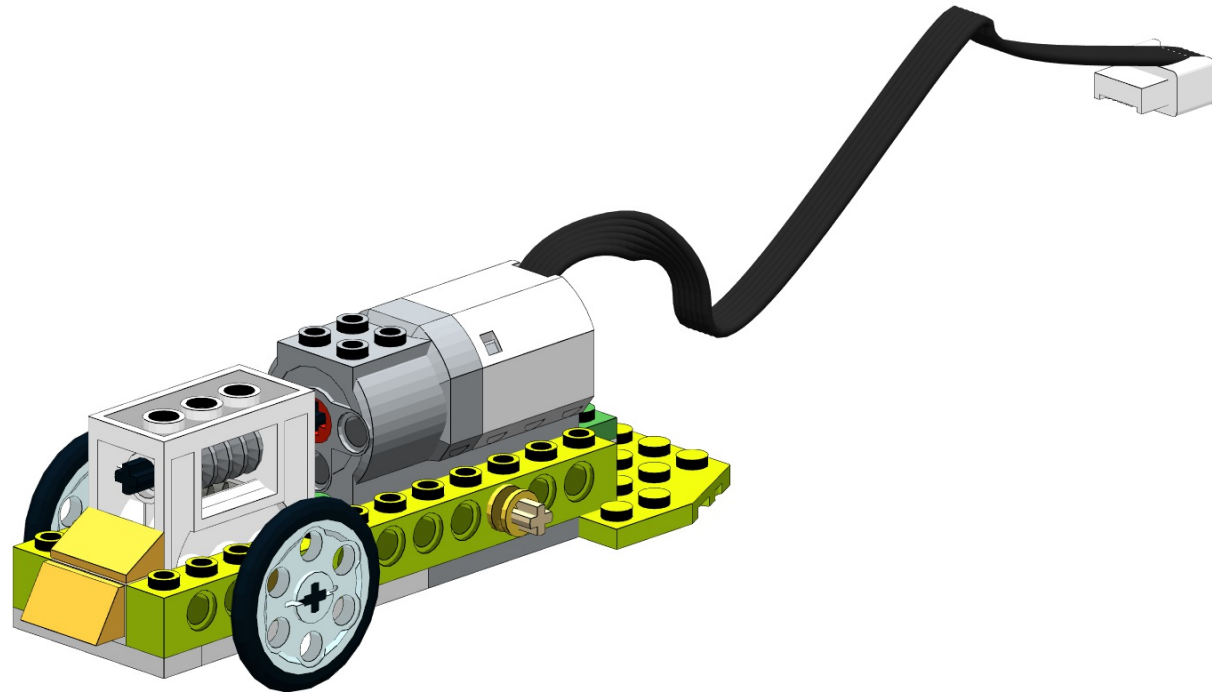
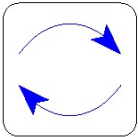

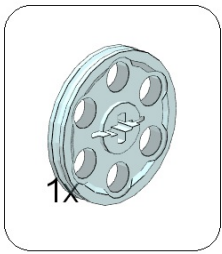

22

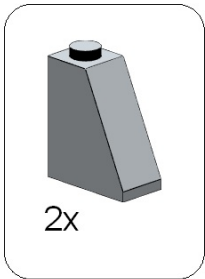
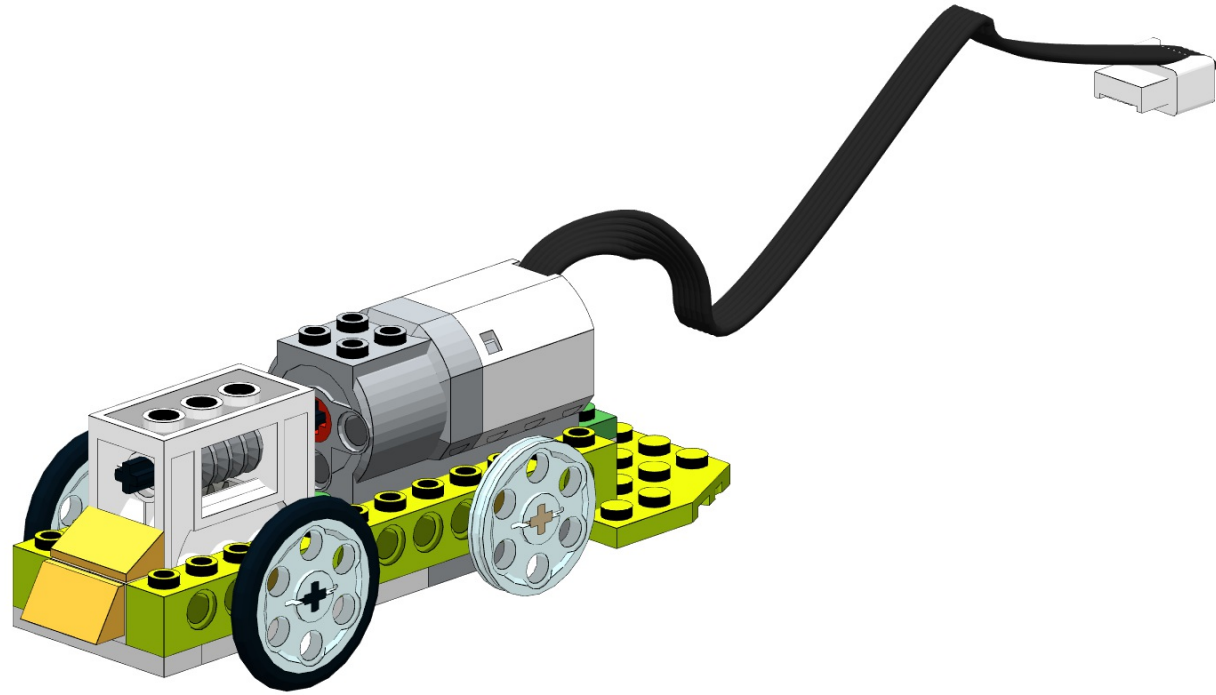

23

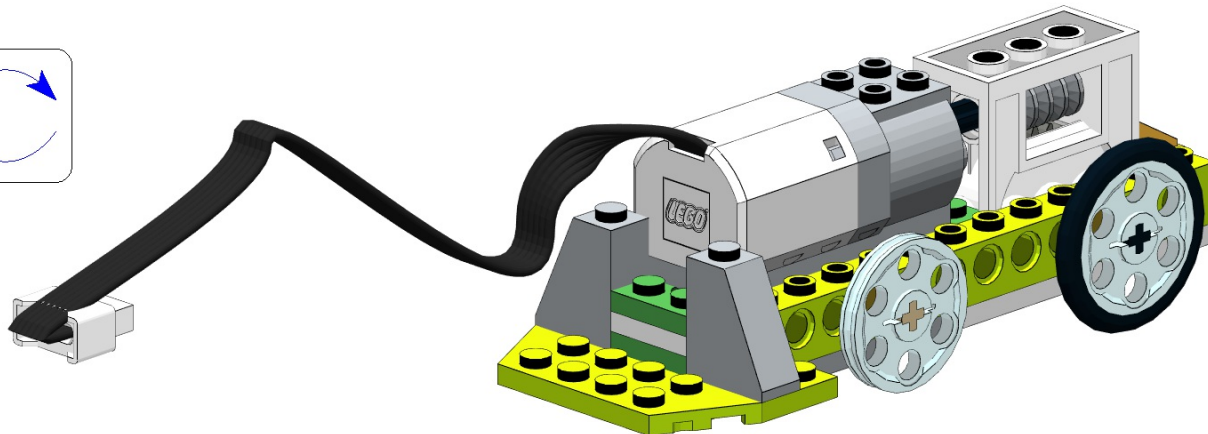
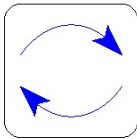

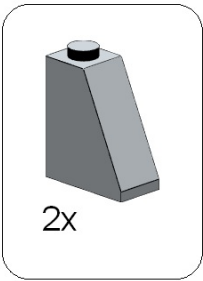

24

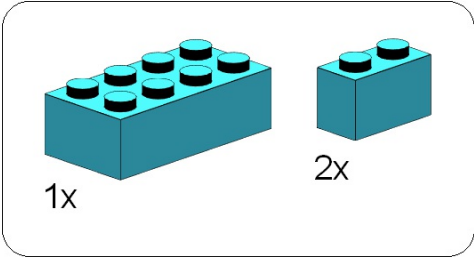
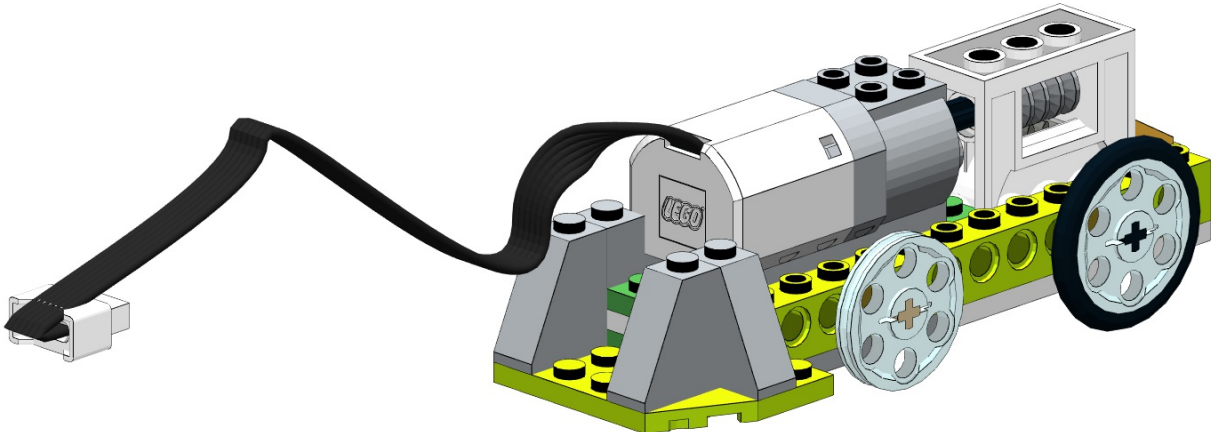

25

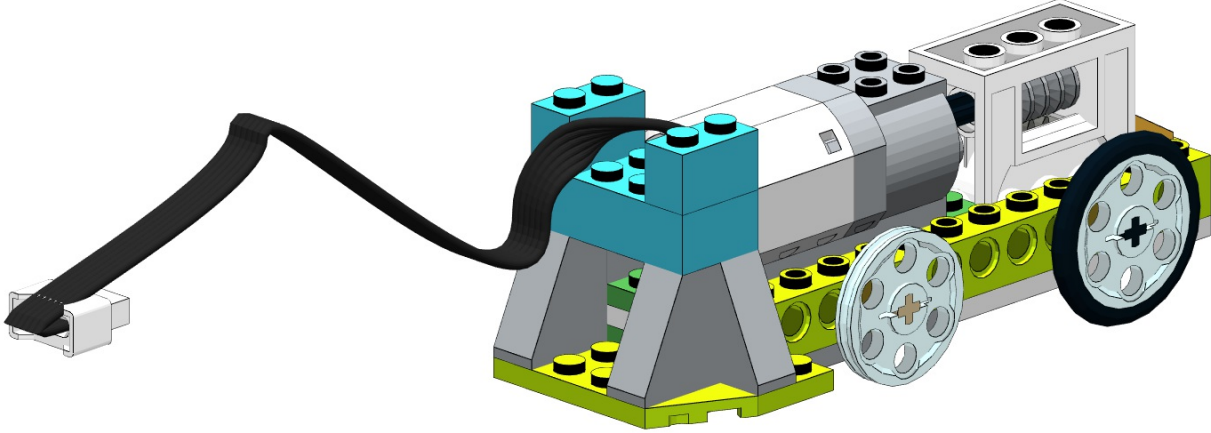

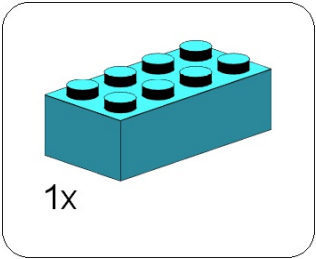

26

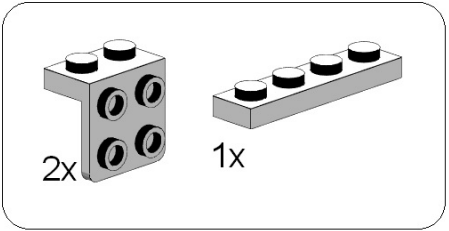
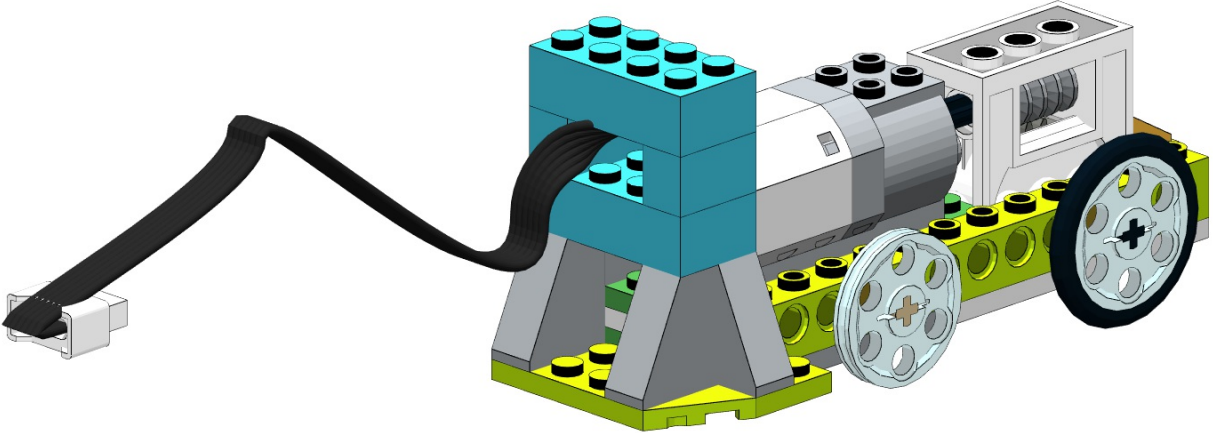

27

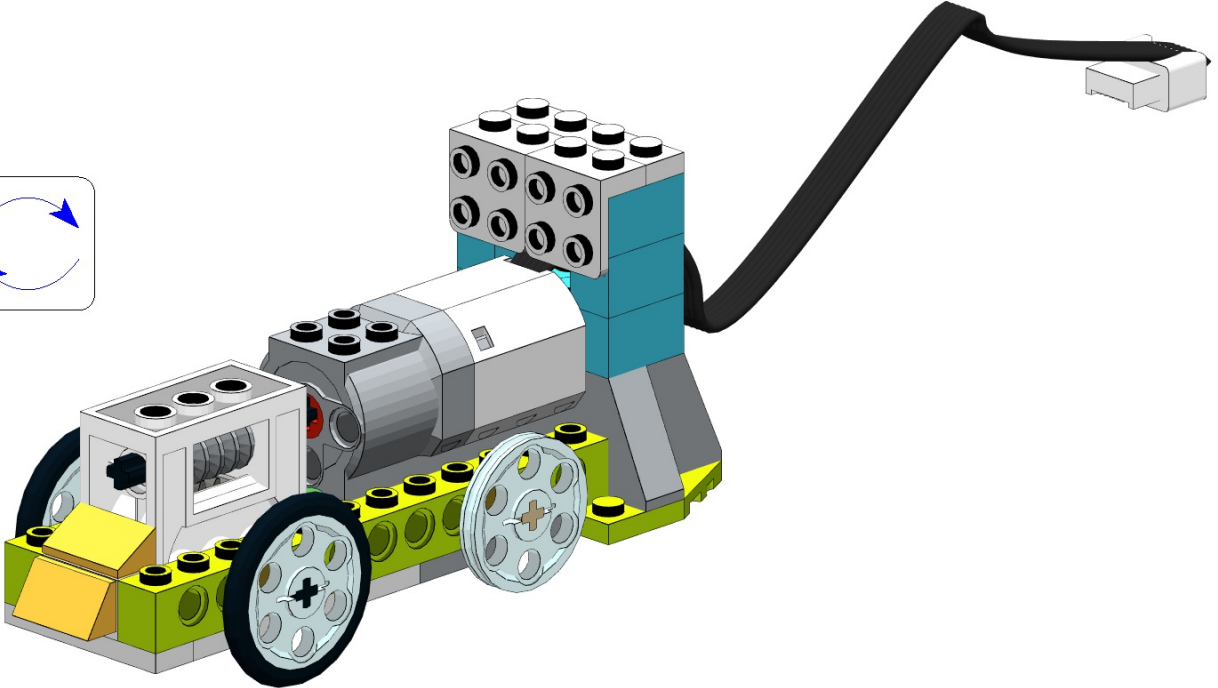
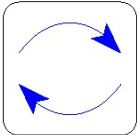

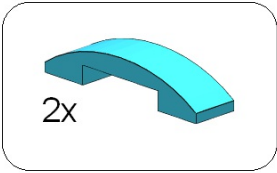

28

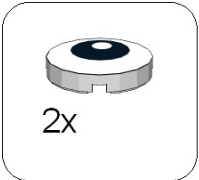
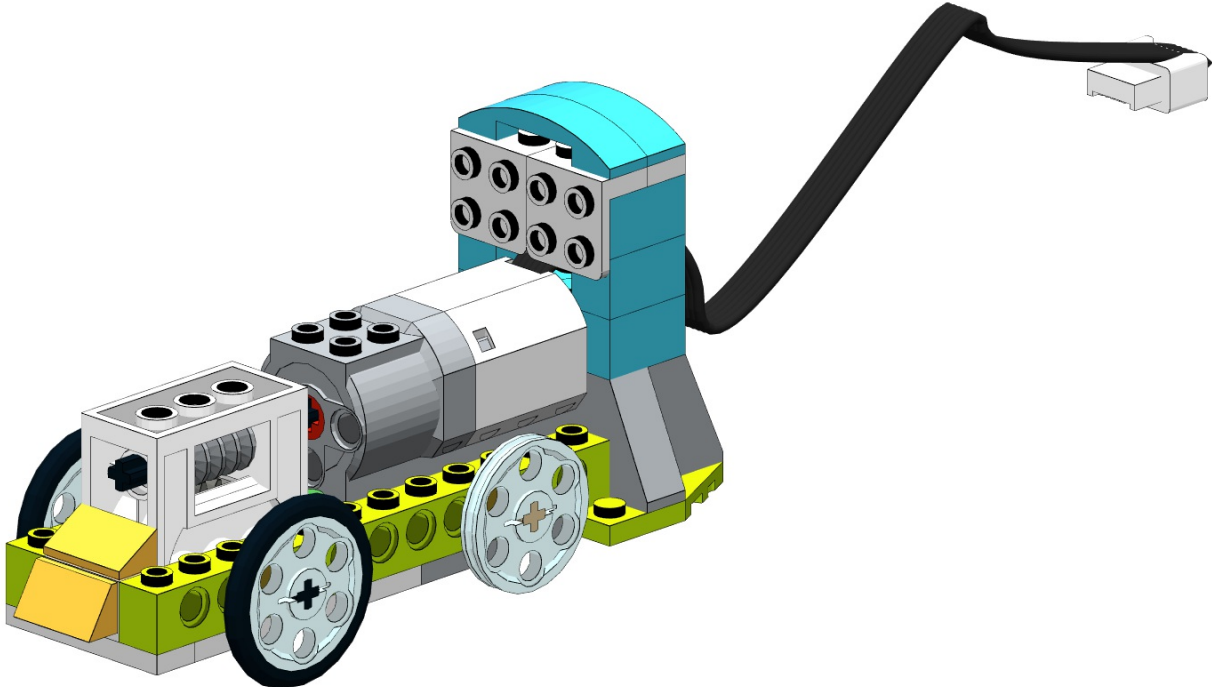

29

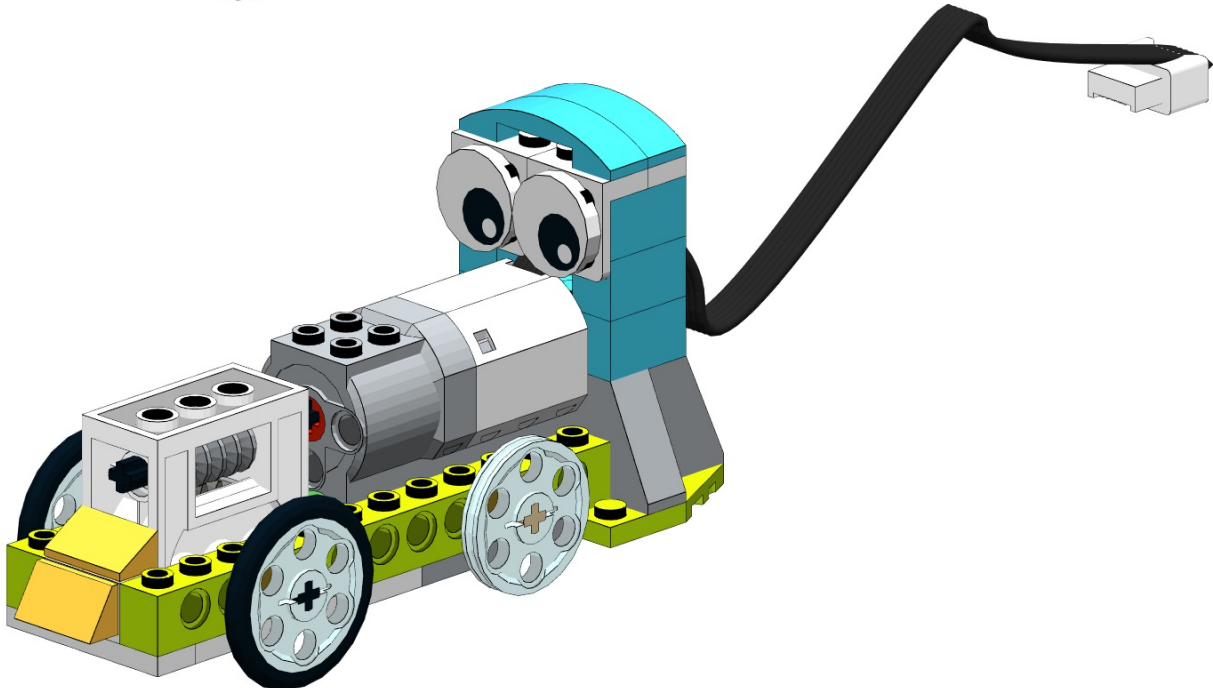

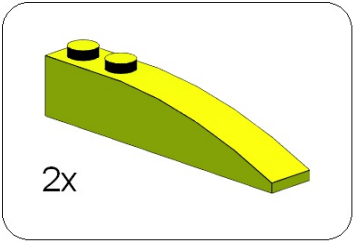

30

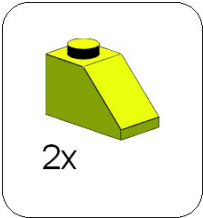
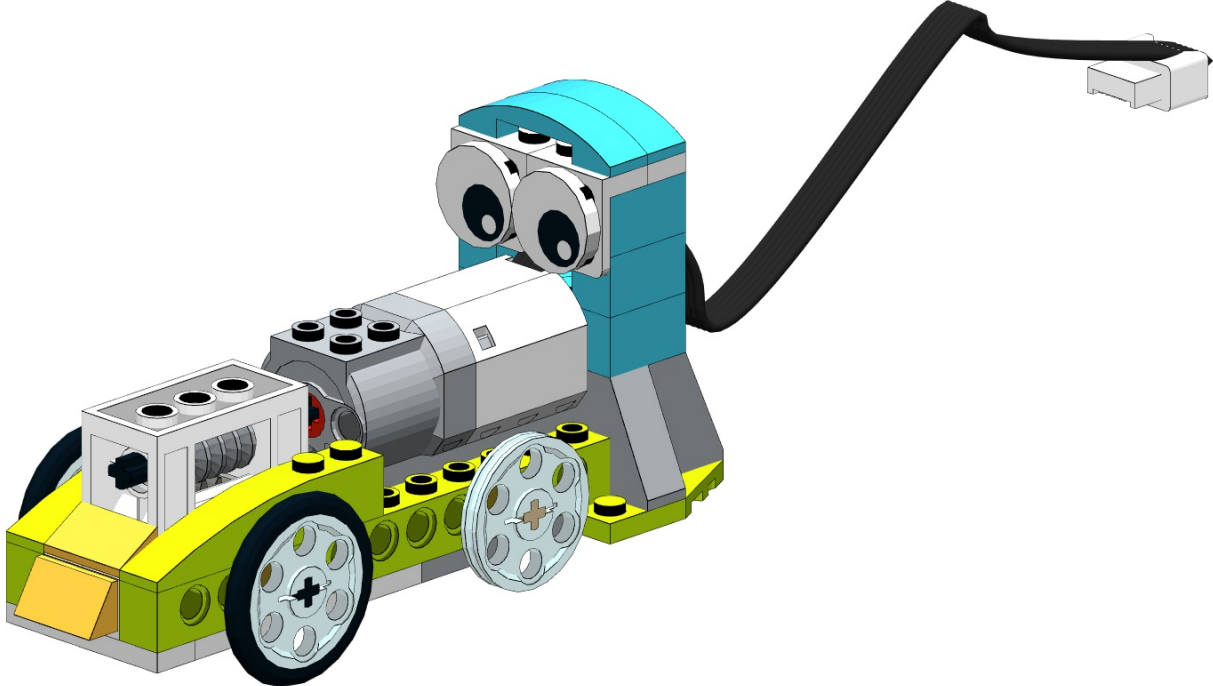

31

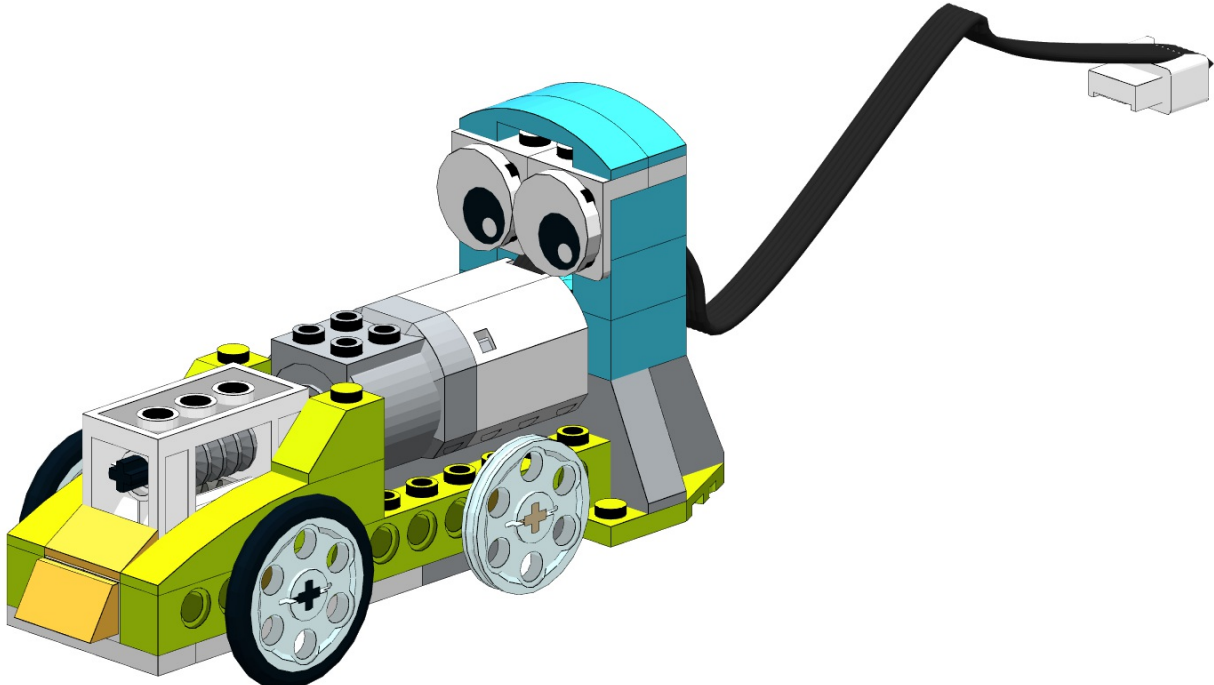

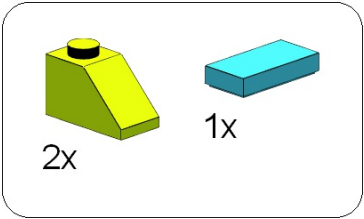

32

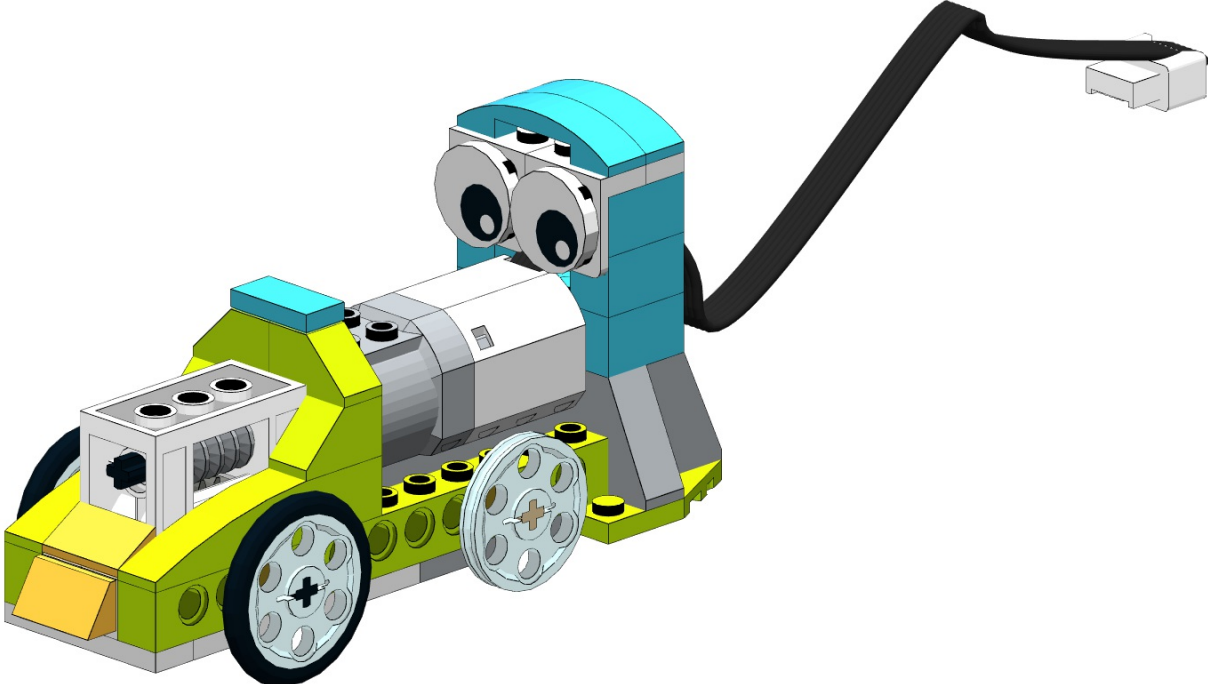

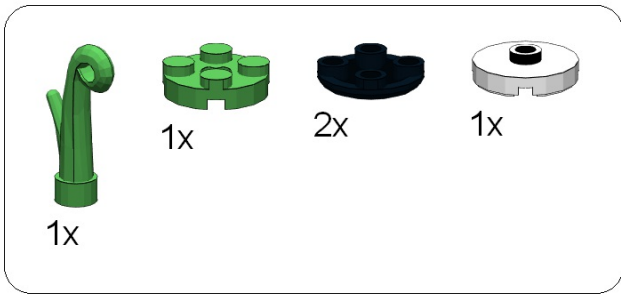

33

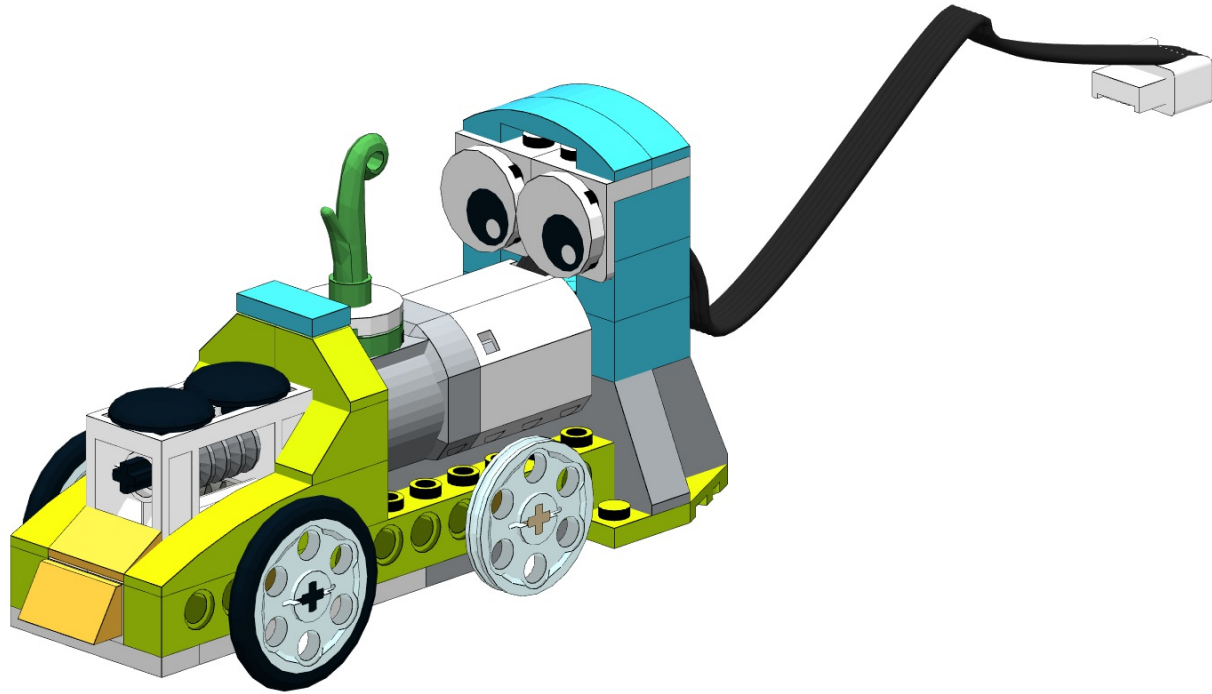

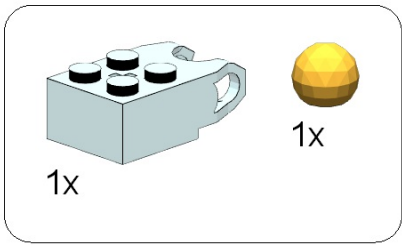

34

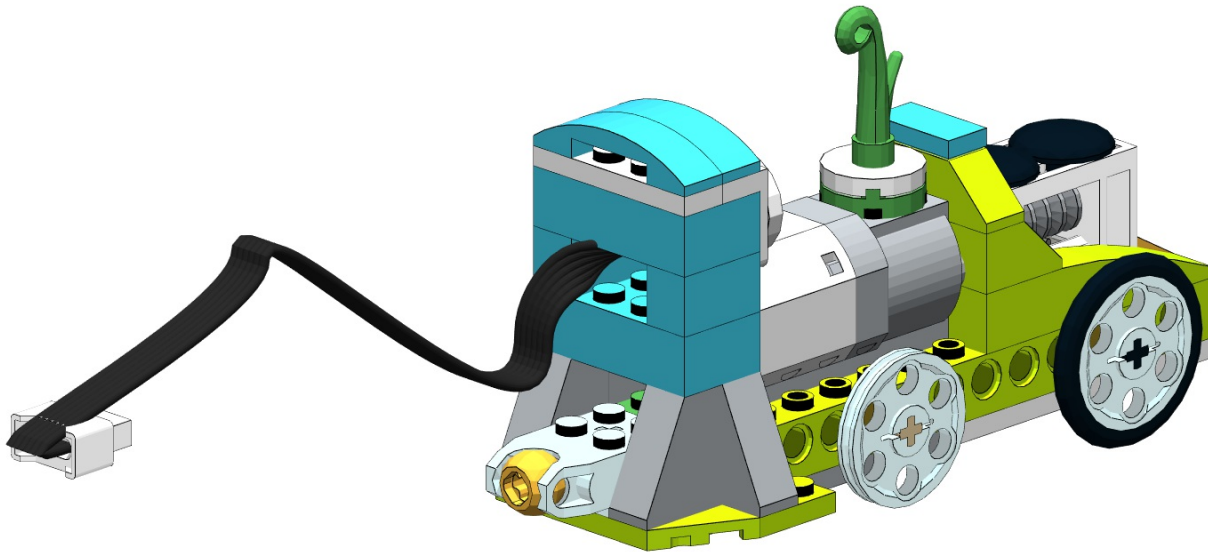
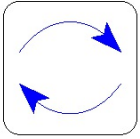

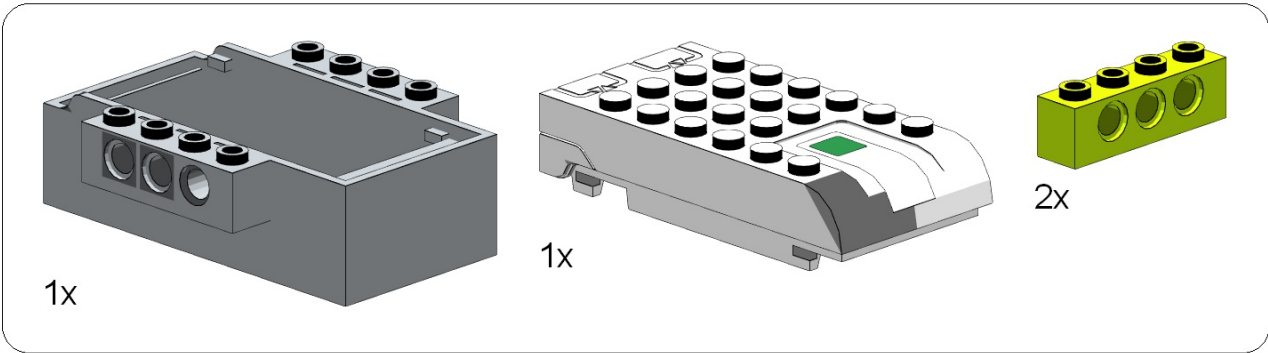
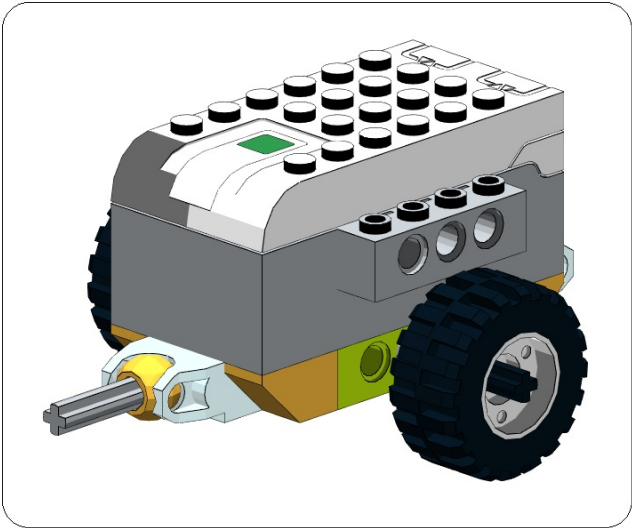

1

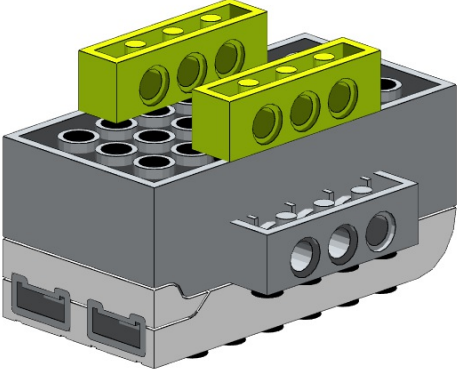

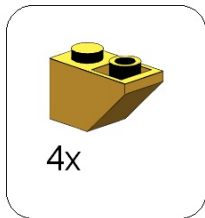

2

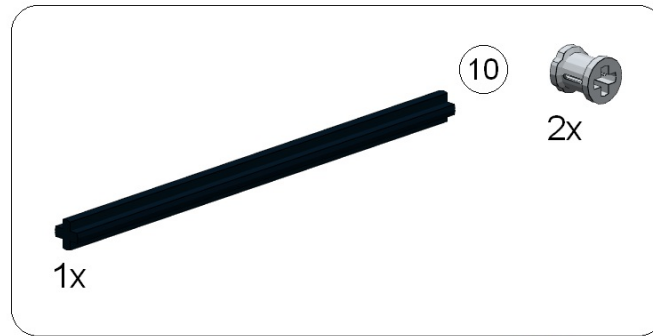
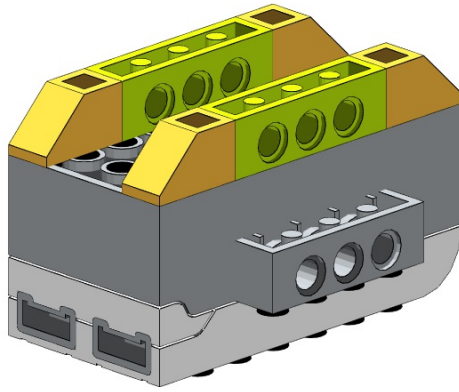

3

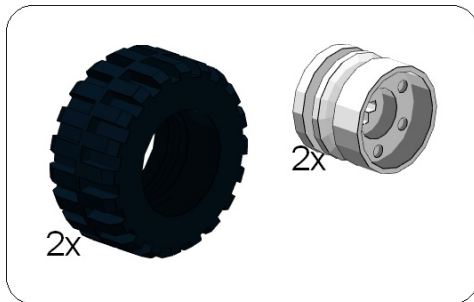
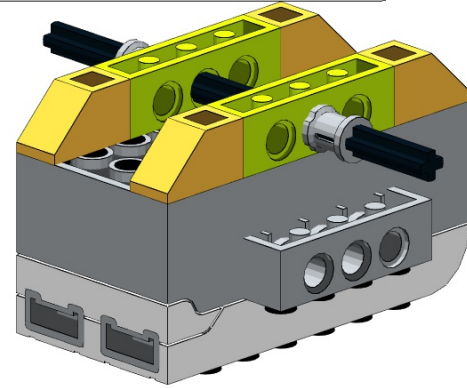

4

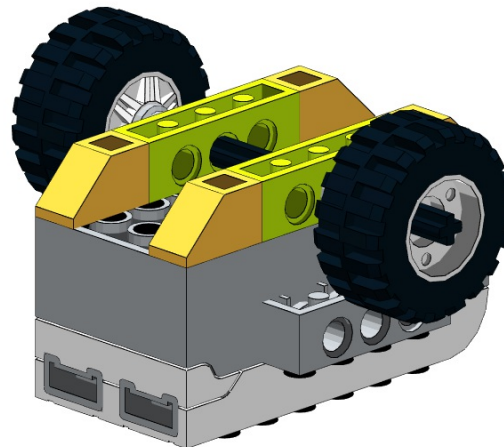

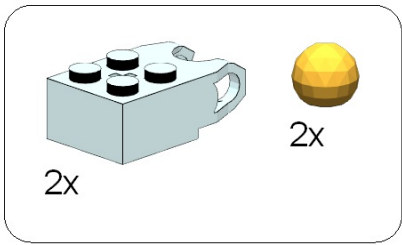

5

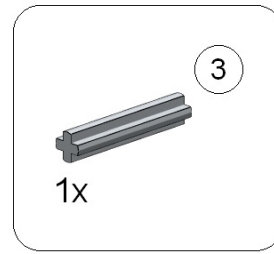
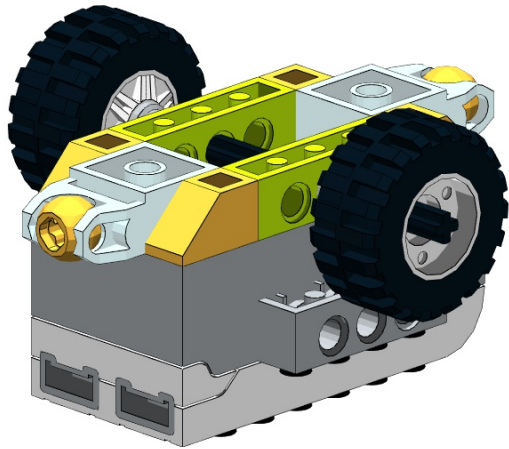

6

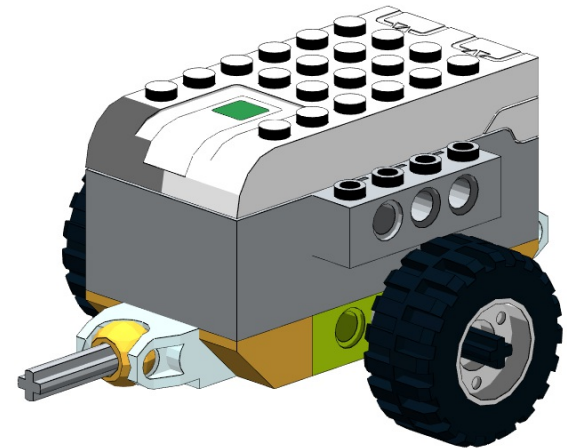
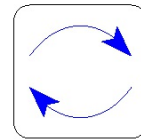

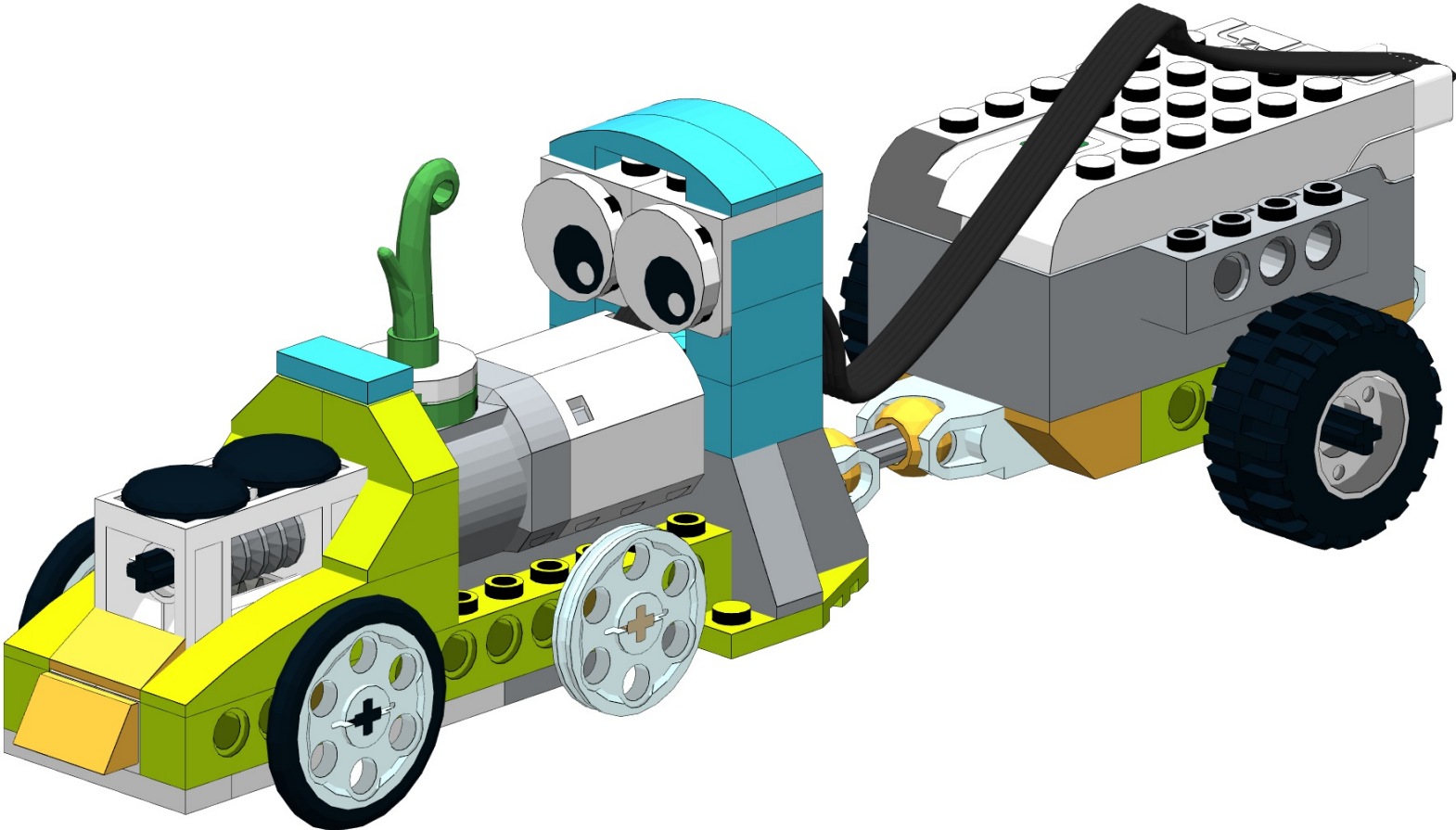

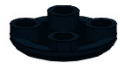

2x



2x



2x

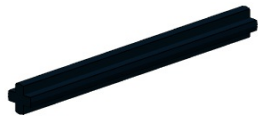

2x



1x



1x



1x

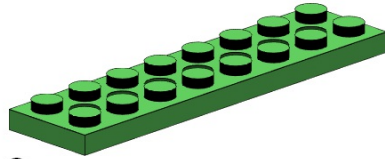

2x

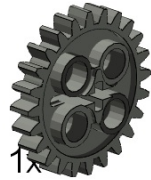

1x



4x

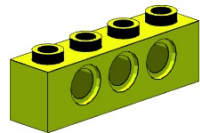

2x

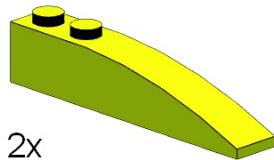

2x

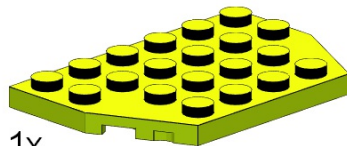

1x

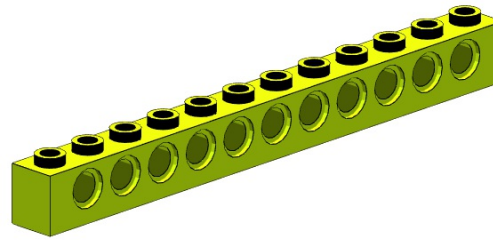

2x

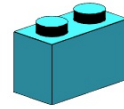

2x

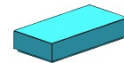

1x

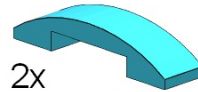

2x

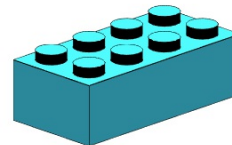

2x



2x

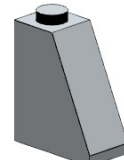

4x



1x



1x

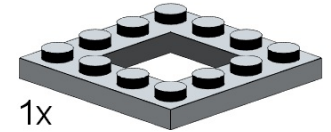

1x

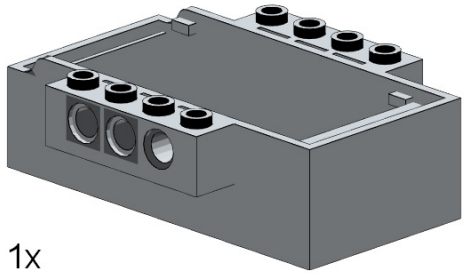

1x



3x

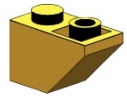

4x

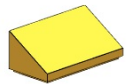

2x



4x

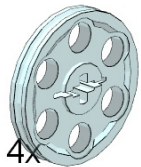

4x

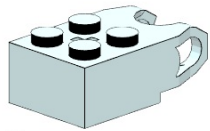

3x



2x

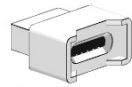

1x

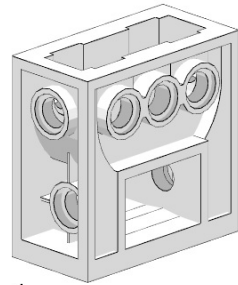

1x



2x

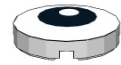

2x

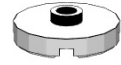

1x

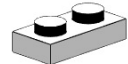

2x

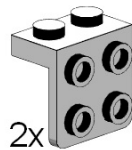

2x

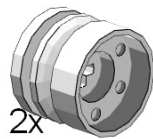

2x

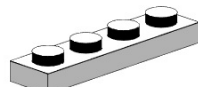

2x

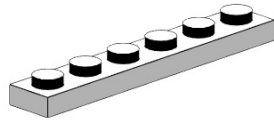

2x

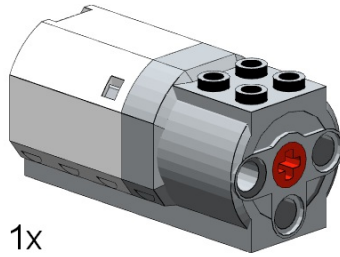

1x

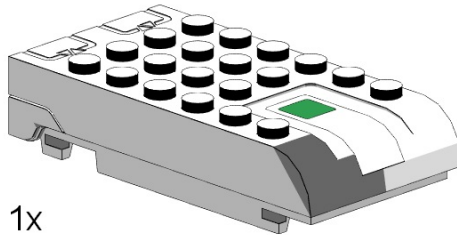

1x