

Ventilateur

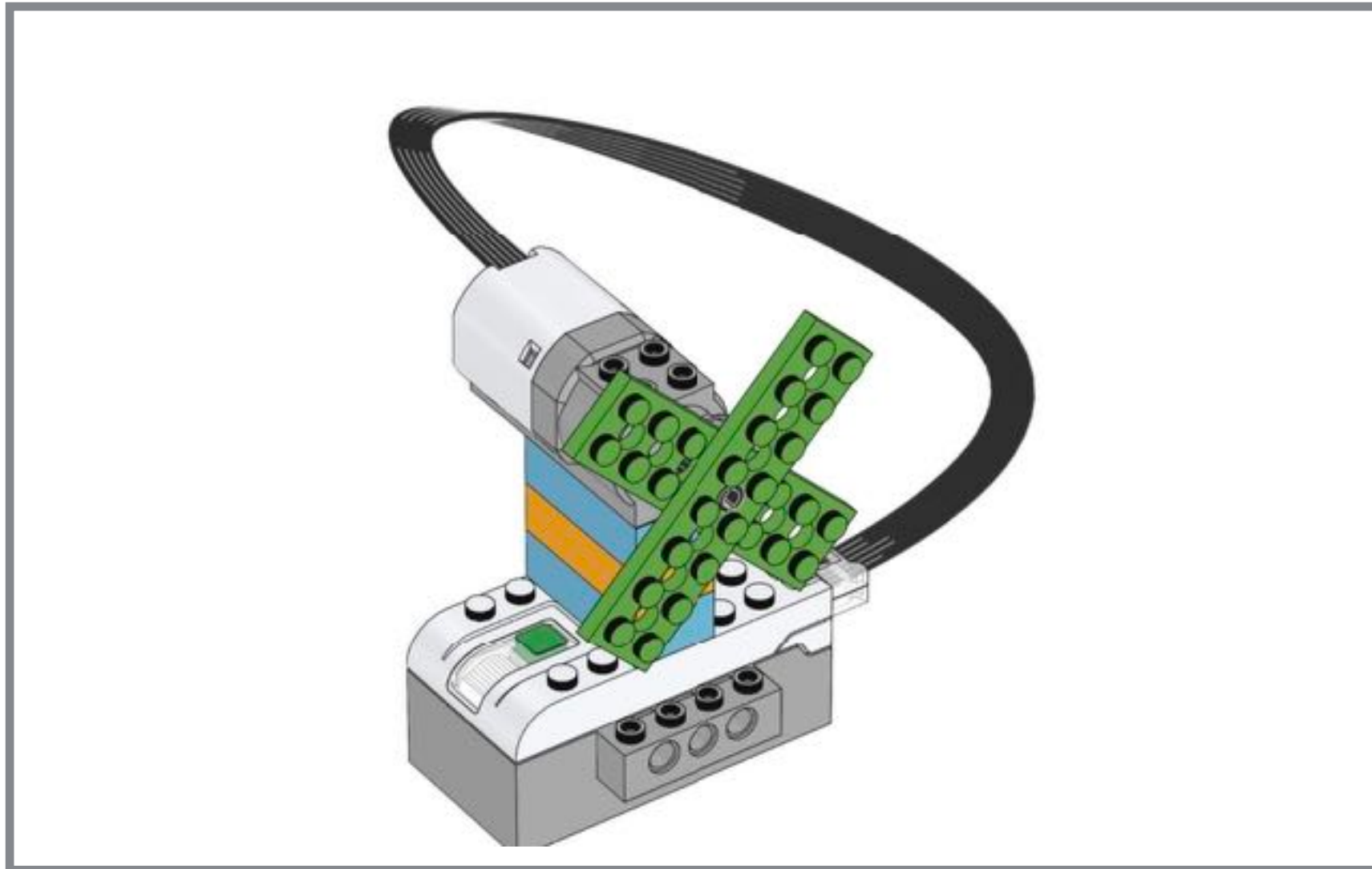

WeDo 2.0 de LEGO Education

Modification et bonification des plans par le Service national du RÉCIT à l'éducation préscolaire



Lynda O'Connell, conseillère pédagogique en TIC et Isabelle Therrien, enseignante à l'éducation préscolaire

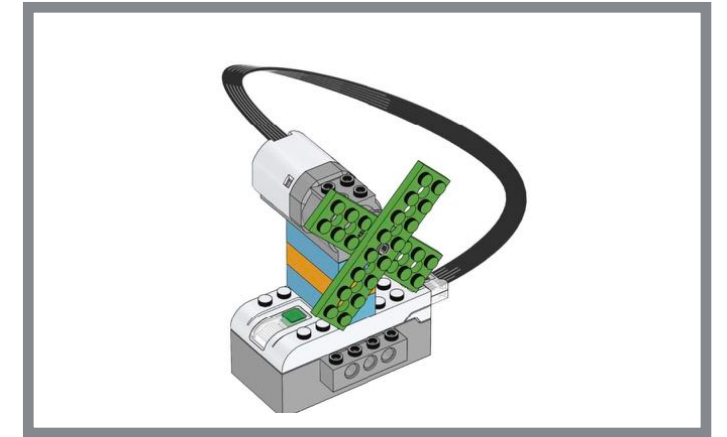

Nombre d'étapes : 9

Nom original du modèle : Ventilateur

Genre de déplacement : Fait tourner ses pales

Complément :

Remarques :

INVENTAIRE DES PIÈCES

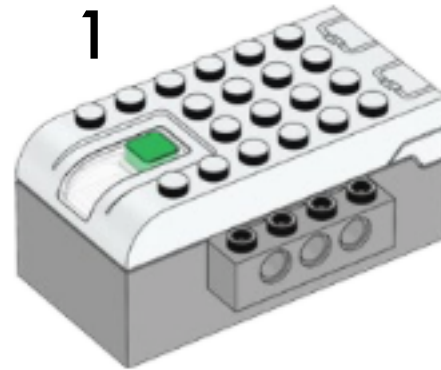
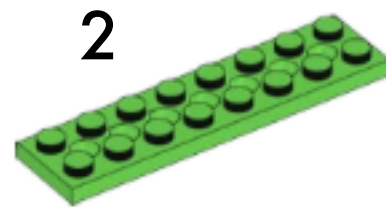
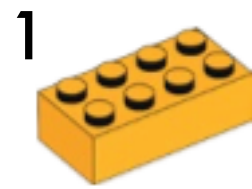
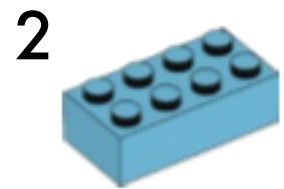
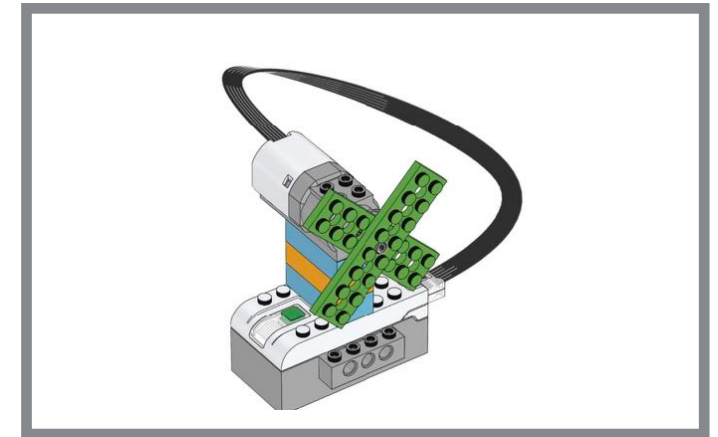

◆ 1 brique intelligente
(blanc)

1

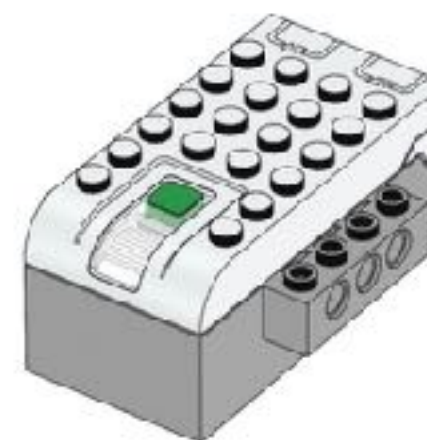
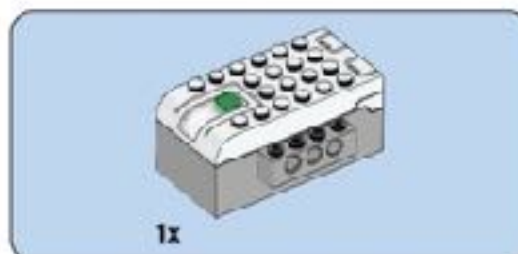

◆ 1 brique, 2x4 (bleu
azur)

2

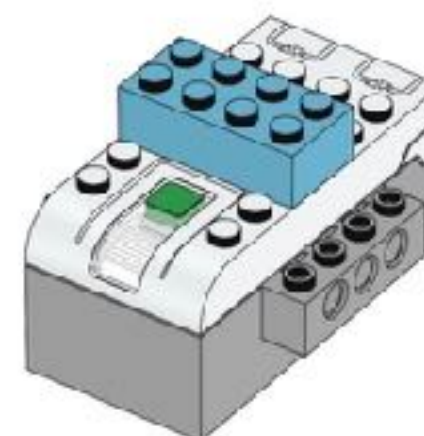
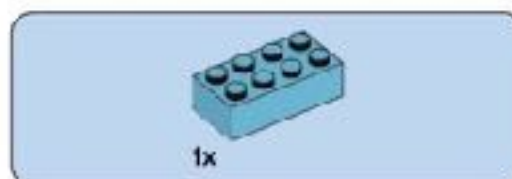

- ◆ 1 brique, 2x4 (bleu azur)
- ◆ 1 brique, 2x4 (orange vif)

3

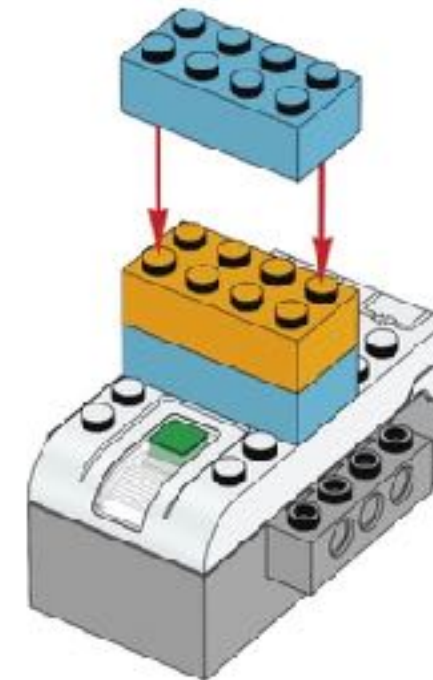
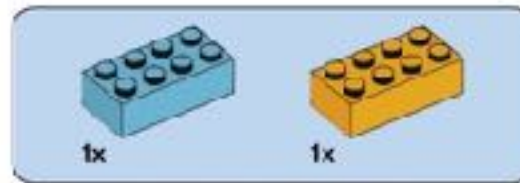

- ◆ 1 moteur moyen (blanc)

4

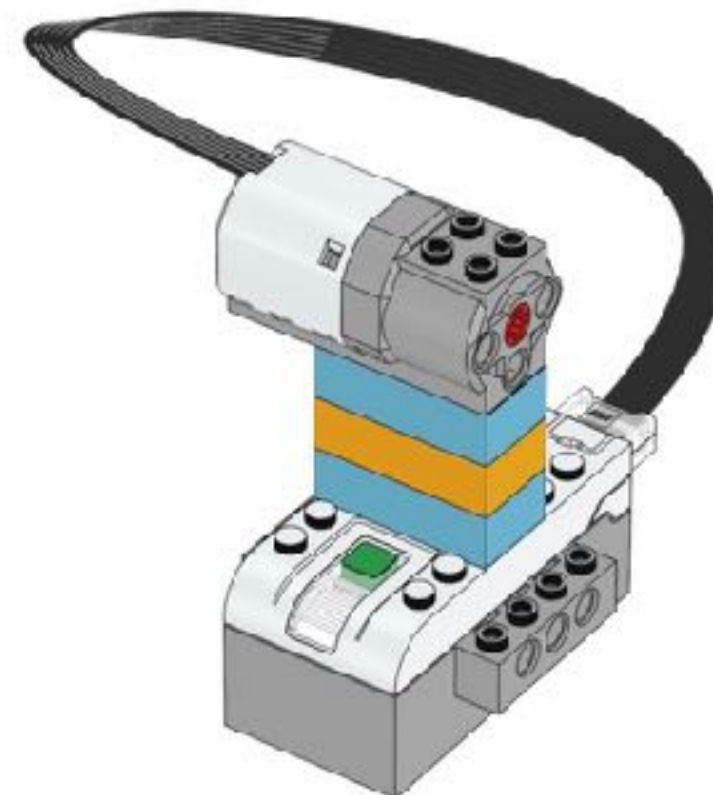
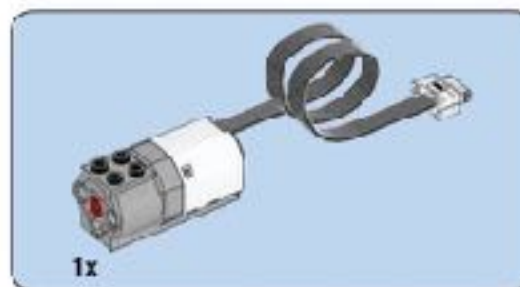

◆ 1 plaque percée, 2x8
(vert vif)

5

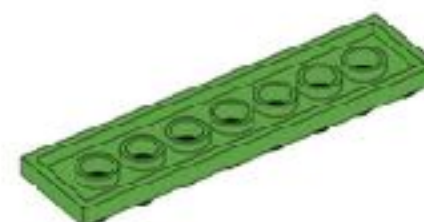
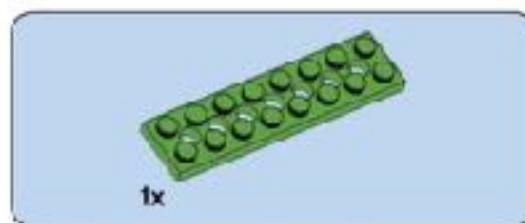

◆ 1 plaque percée, 2x8
(vert vif)

6

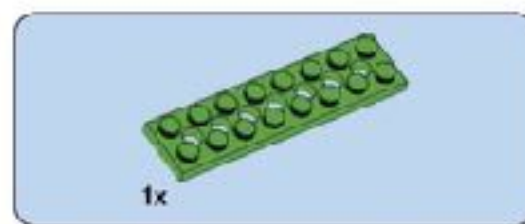

- ◆ 1 cheville d'assemblage avec axe, 3 modules (noir)

7



8

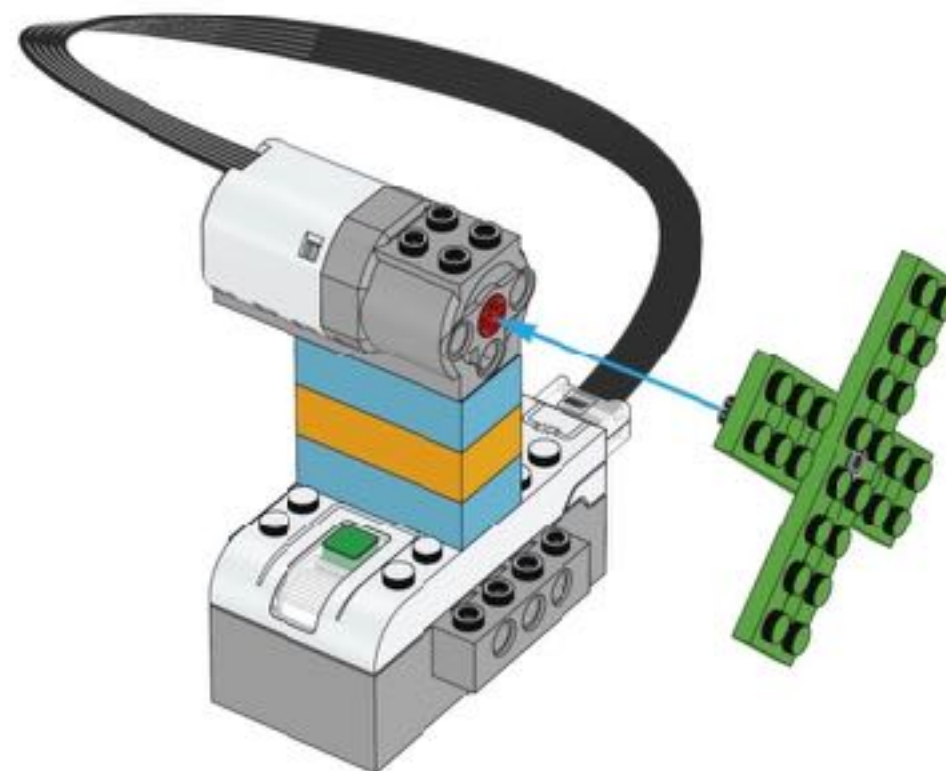

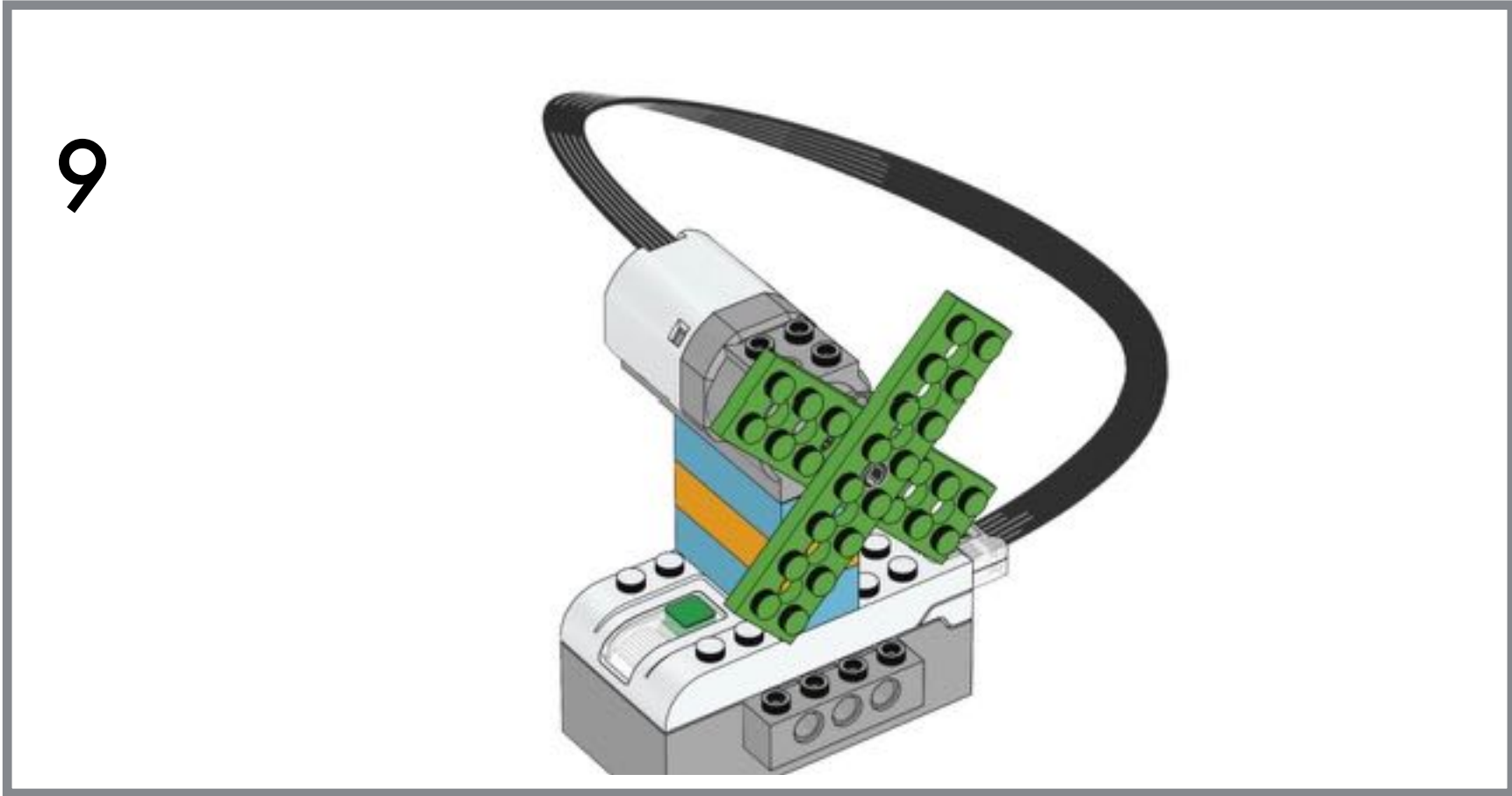
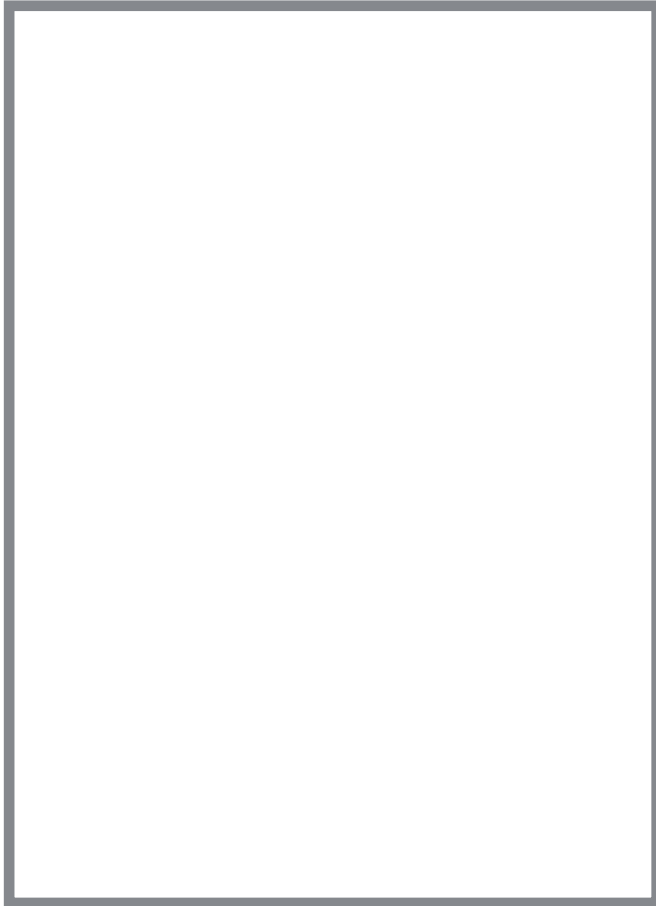

BRAVO!

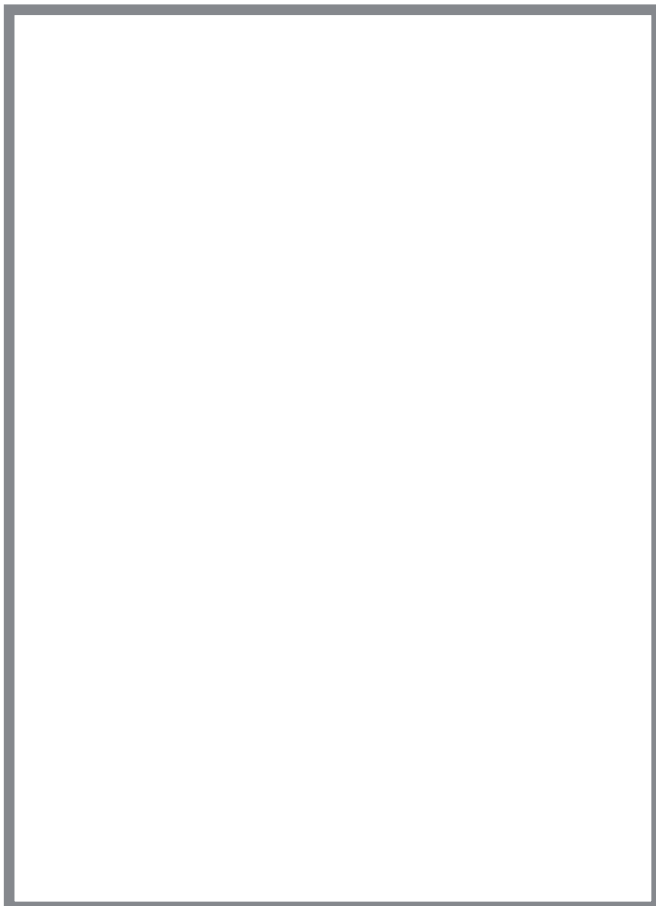

11

